

Harvia MiniMy 120 Basic

HARVIA

Infrared cabin

Instructions for installation and use

120 x 130 x 202 cm

Item no.

MINIMY-120-B



EN

DE

FR

IT

NL

PT



CE UK
CA

1. About this instruction manual	3
2. Important information for your safety	4
2.1. Intended use	4
2.2. Safety information	4
3. Product description	6
3.1. MiniMy scope of delivery	6
3.2. Product features	7
4. Installation of the MiniMy infrared cabin	8
4.1. Tools required	8
4.2. Parts list for MiniMy infrared cabin	9
4.3. Cabin installation	11
4.4. Installing the interior fittings	22
4.5. Installing the infrared heater and heat panel	23
4.6. Installing the LED strip	25
4.7. Installing the infrared control unit	27
4.8. Installing the bench	29
4.9. Installing the backrests and headrests	30
4.10. Installing the doors	32
5. Cleaning and maintenance	35
5.1. Cleaning	35
5.2. Maintenance	35
6. Troubleshooting	35
7. Disposal	35
8. Technical data	36
9. Floor plan	36
9.1. "Left-hand door" floor plan	36
9.2. "Right-hand door" floor plan	37
9.3. Changes for installation with "right-hand door" floor plan	38

1. About this instruction manual

Read these installation and operating instructions carefully and keep them within reach of the infrared cabin. This ensures that you can refer to information on safety and operation at any time.



These installation and operating instructions can also be found in the downloads section of our website: www.mediabank.harvia.com.

Symbols used for warning notices

In these instructions for installation and use, a warning notice located next to an activity indicates that this activity poses a risk. Always observe the warning notices. This prevents damage to property and injuries, which in the worst case may be fatal.

The warning notices contain keywords, which have the following meanings:



DANGER!

Serious or fatal injury will occur if this warning notice is not observed.



WARNING!

Serious or fatal injury can occur if this warning notice is not observed.



CAUTION!

Minor injuries can occur if this warning notice is not observed.

ATTENTION!

This keyword is a warning that damage to property can occur.

Other symbols



This symbol indicates tips and useful information.



Do not cover

2. Important information for your safety

The infrared cabin has been produced in accordance with the applicable safety regulations for technical units. However, hazards may occur during use. Therefore adhere to the following safety information and the specific warning notices in the individual chapters.

2.1. Intended use

The infrared cabin is used for the heating of the human body.

The cabin location must be protected from splashing water. For optimal operation, the location should have an ambient temperature of at least 20 °C. The maximum ambient air humidity should not exceed 95%.

EN

The cabin must be erected on a level surface. A distance of at least 5 cm from the wall must be maintained.

Any use exceeding this scope is considered improper use. Improper use can result in damage to the product, severe injuries or death.

2.2. Safety information

- Installation and connection of the electrical parts (control unit, heater, etc.) may only be performed when the power supply is disconnected.
- Also comply with the regulations applicable at the installation location.
- For your own safety, consult your supplier in the event of problems that are not explained in sufficient detail in the installation instructions.

- The cabin may not be used by children under 8 years old.
- The cabin may be used by children over 8 years old, by persons with limited psychological, sensory or mental capabilities or by persons with lack of experience/knowledge only under the following conditions:
 - They are supervised.
 - They have been shown how to use the device safely and are aware of the hazards that could occur.
- Children may not play with the cabin.
- Children under 14 years of age may only clean the cabin if they are supervised.
- The cabin may not be cleaned with steam cleaners, high-pressure cleaners or splashed water.
- For health reasons, do not use the sauna when under the influence of alcohol, medication or other drugs.
- Before the control unit is switched on, make sure that no combustible objects have been placed on the heating elements.

3. Product description

3.1. MiniMy scope of delivery

- 1x 1-045-570 / MiniMy infrared cabin
- 1x 1-037-357 / Power supply unit wave.com4 Infra
- 1x 1-012-222 / Operating unit wave.com4 Infra
- 1x 1-009-265 / Infrared mains connection cable, 2.5 m
- 1x 1-027-788 / ECO 500 infrared heater - dark (pre-assembled) - front heater
- 1x 1-027-785 / ECO 350 infrared heater - dark - back heater
- 1x 1-028-348 / IR heat panel, 380 mm x 700 mm, 230 V / 100 W (pre-assembled)
- 1x 1-037-397 / Switch set, IR heat panel (pre-assembled)
- 1x 1-028-660 / Round vent, aspen 631-A
- 1x 1-028-629 / Soapstone bowl
- 1x 1-052-935/ LED-Set WC4-Infra

EN

3.2. Product features

Infrared cabin

Cabin made of solid spruce wood for the infrared radiation of one person.



Pitch pockets are not grounds for return, since they can always appear in spruce wood and the depth at which they lie cannot be detected during the sorting-out process.

If these are just under the surface, heat can cause them to soften and “bleed”.

The leaking pitch can be removed with a rag soaked in acetone. If only droplets of pitch occur, allow these to harden and then carefully scrape them off with a knife.

Infrared control unit wave.com4 Infra

Control unit for the dimming of two heating circuits (each with a maximum of 1.5 kW) and for dimming the light and an optional fan.



This control unit only supports the “intensity regulation” operating mode.

4. Installation of the MiniMy infrared cabin

Before you begin work, check the parts list to ensure that all the individual parts have been delivered. If you discover any missing parts, notify your dealer within 14 days of receiving the sauna cabin.



You need an assistant for assembly.

We also advise you to pre-drill the holes for the screws.

4.1. Tools required

- Hammer with a wooden head or a mallet
- Cordless screwdriver with bits for cross-head screws and Torx
- Roller tape measure
- Spirit level
- Punch or wood blocks, 12 mm
- Allen key, 1.5 mm

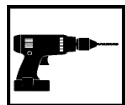

Pre-drill



Check the right angle:

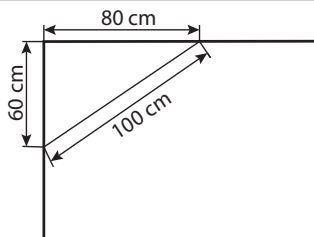

Handle glass with care: Special care must be taken with the edges of the glass – hardened glass can shatter into small pieces in the event of impact. Insert protective cushioning (e.g: cardboard box) under the edge of the glass.

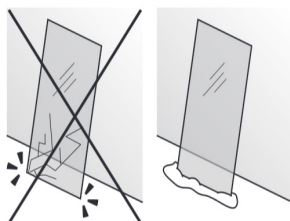

4.2. Parts list for MiniMy infrared cabin

No. of items	Name	Dimensions
Base frame		
1	Base frame, rear	103 x 9 x 4 cm
1	Base frame, right	114 x 9 x 4 cm
1	Base frame, left	42 x 9 x 4 cm
Wall elements		
2	A/A wall element with Multiclip	193 x 54 x 4 cm
1	A/A wall element with Multiclip	193 x 36 x 4 cm
1	A/B wall element with heater recess	193 x 45.5 x 4 cm
1	A/B wall element with recesses for heater and operating unit	193 x 45.5 x 4 cm
1	Glass element with Multiclip	202 x 103 x 4 cm
1	Door frame	202 x 72 x 4 cm
Ceiling elements		
1	A/B ceiling element with fan recess	107 x 45 x 4 cm
1	A/B ceiling element	107 x 45 x 4 cm
Corner posts		
2	Corner posts 90°	193 x 6 x 6 cm
Support slats		
1	Roof support slat	112 x 4 x 4 cm
1	Roof support slat with drill hole	112 x 4 x 4 cm
1	Roof support slat	95 x 4 x 4 cm
1	Roof support slat with drill hole	95 x 4 x 4 cm
1	Bench support, left	41 x 56 x 4 cm
1	Bench support, right	41 x 56 x 4 cm

No. of items	Name	Dimensions
Interior fittings		
1	Spruce heater box	105 x 23 x 12 cm
1	IR heat panel incl. lattice	79.8 x 42 x 4.5 cm
1	Bench	94.5 x 56 x 10 cm
2	Ergonomic backrest	70 x 18 x 10.5 cm
1	VitaMy headrest	35 x 27.5 x 8 cm
1	Frame for 350 W heater, lime wood	73.5 x 23 x 2 cm
1	LED cover strip	95 x 3 x 3 cm
1	Spruce base	94.4 x 61.8 x 4 cm
Glass element		
1	Glass door	191.5 x 59 x 0.8 cm
Accessories		
1	Door handle set wood/wood	
1	Door magnet, sleeve plate	
1	2 door hinges 8653-02	
2	Mounting rail for headrest	13.5 x 2 x 2 cm
1	Template for Multiclip backrest assembly	
1	Template for Multiclip glass front assembly	
2	Rear wall cover strip	202 x 5 x 4 cm
1	Installation material	
1	Installation instructions	

4.3. Cabin installation

The cabin can have a “left-hand door” or “right-hand door” set-up; please note the corresponding floor plans on Page 34 and Page 35.

Base frame installation

Fig. 1: Laying the three base frame elements

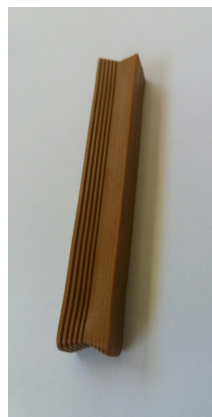
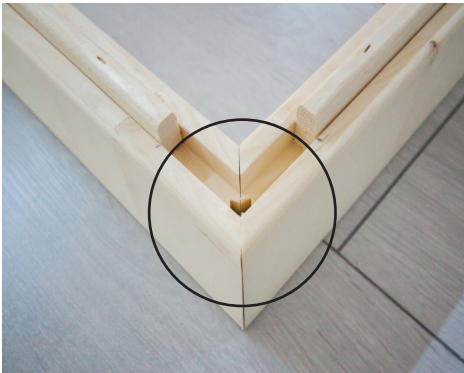

Fig. 2: Connecting the base frame

With a hammer, carefully drive in the plastic dovetail keys on both corners of the base frame until they are flush with the groove of the element.

Use a punch or a wooden block so that the plastic dovetail key is adequately sunk.



EN

Wall element assembly

The corner posts are connected to the wall elements using Multiclips. The other wall elements are connected tongue and groove and are screwed together.

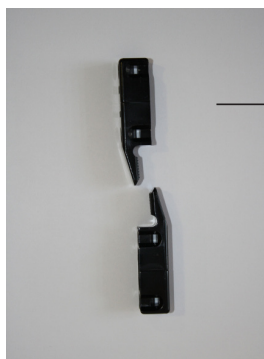
Fig. 3: Multiclips

Corner posts

Attention!

The installation subsequently described is for the “left-hand door” floor plan. For changes affecting the installation for the “right-hand door” floor plan - see Page 35.



A always refers to the visible side. This is labelled on the top side of the wall elements.

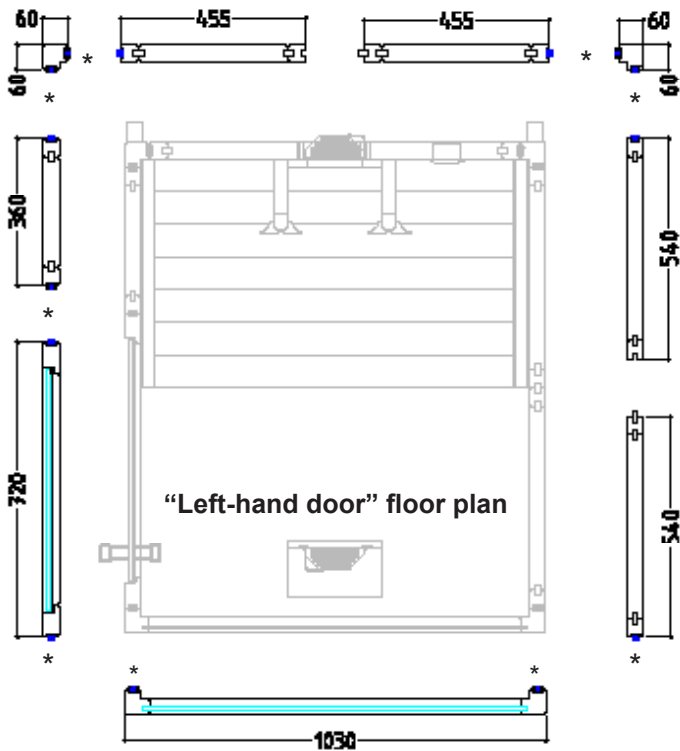

* Multiclips

Fig. 4: Connecting wall elements with corner post

EN

Insert the corner post from above down onto the wall elements. When doing this, ensure that the Multiclips are correctly aligned (see Fig. 44). The corner post must be flush with the wall elements.

Fig. 5: Installation on base frame

Fig. 6: Inserting wall element with recess

EN

After you have inserted the heater element, proceed with the second corner.

Fig. 7: Pre-assembled wall elements

Fig. 8: *Screwing wall elements together*



Check the right angle before screwing the wall elements together.
Observe the tip on Page 8.



EN

3 mm drill bit, 2 screws 4 x 70 mm

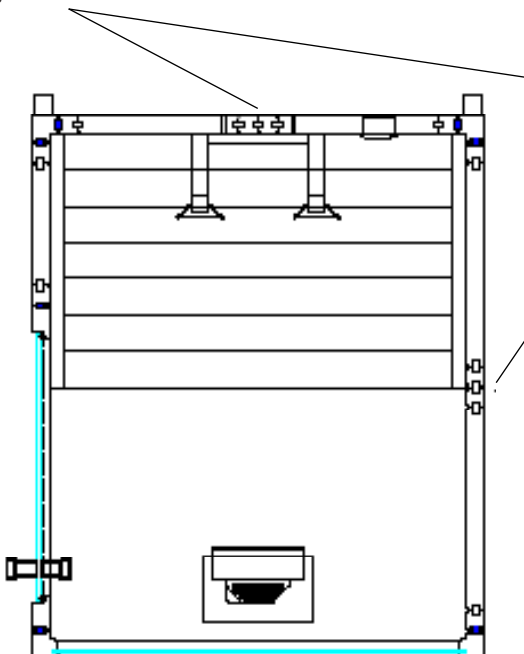

Fig. 9: Installing the glass element



EN

Fig. 10: Installing the door frame



Installing the roof elements



Check the right angle before screwing the wall elements together. Observe the tip on Page 8.

Fig. 11: Installing the roof support slats

Screw the roof support slats tight on all cabin walls as shown in Fig. 11. When doing this, ensure that the wall elements form a flush edge with the roof support slats.

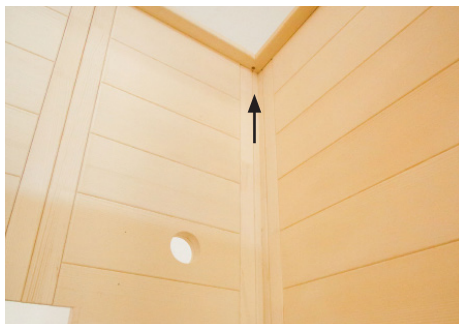

16 screws: 3.5 x 50 mm

Position of slat with drill hole

Fig. 12: Roof support slats



Fig. 13: Inserting rear ceiling element with fan recess

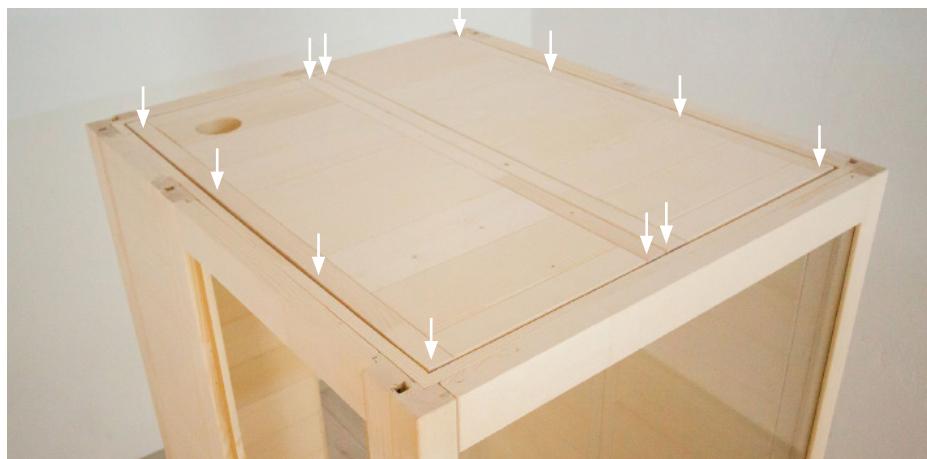

Fig. 14: Inserting front ceiling element



EN

Fig. 15: Fastening the ceiling elements



12 screws: 3.5 x 35 mm

Fig. 16: Installing rear wall cover strips

Screw the cover strips tight on the rear wall, either flush or offset up to 10 cm towards the inside.



EN

4 screws: 4 x 70

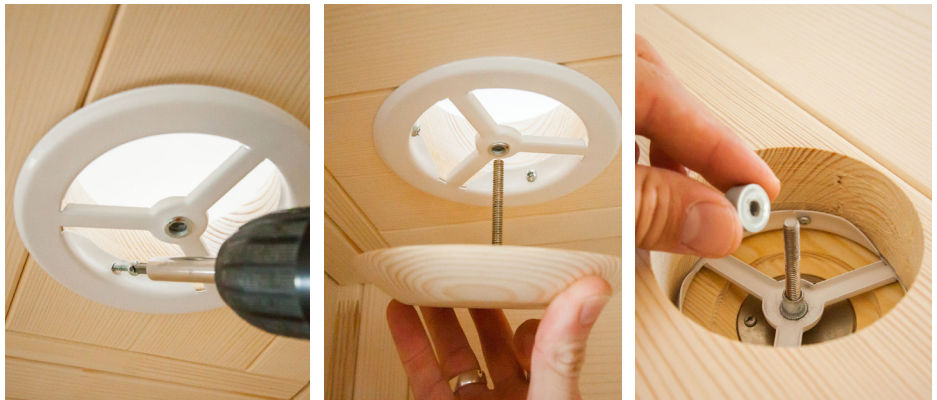
Installing the vent**Fig. 17: Installing the vent**

Screw the basic vent element tight with the three supplied screws. Next, screw in the wood plate and secure the screw from the outside with the plastic cap.

4.4. Installing the interior fittings

Fig. 18: Installing the bench supports



4 screws: 4 x 70 mm

4 screws: 4 x 70 mm

Fig. 19: Laying the floor

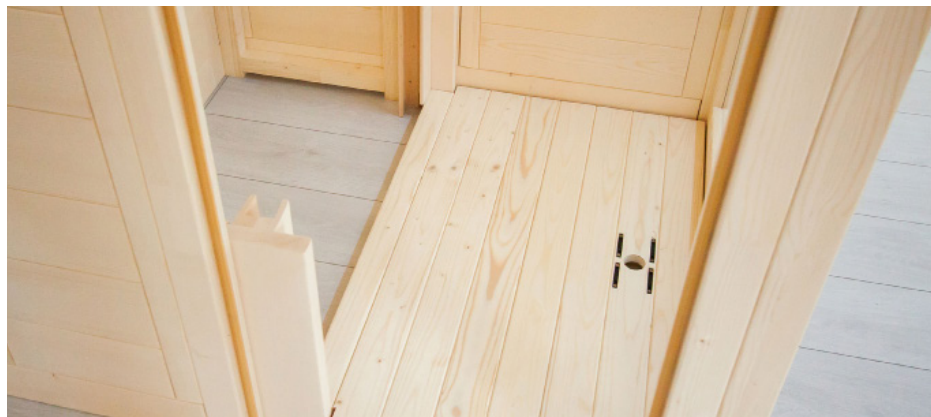

4.5. Installing the infrared heater and heat panel

Fig. 20: Attaching the front heater



Ensure that the front heater cables lie free on the floor and are not pinched by the cabin flooring or otherwise damaged.



EN

Once the heater is fitted into the recess on the floor, fasten it by turning the Allen screws clockwise 90° at the four fastening points.

Fig. 22: Inserting the soapstone bowl**Fig. 21: Installing the back heater (ECO 350 infrared heater)****CAUTION!**

Make sure that the connection box of the heater is on the top side!

EN

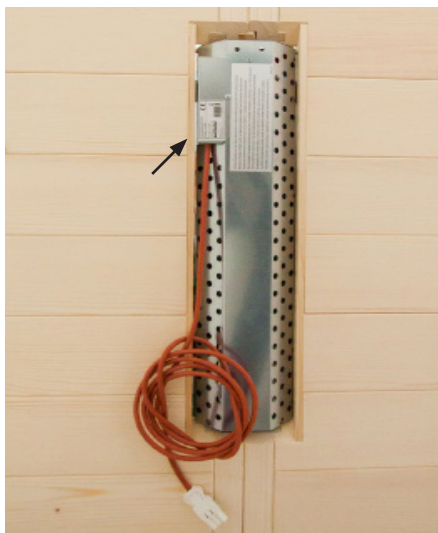

4 screws: 3 x 18 mm

Insert the heater from the inside into the recess. Screw the heater tight with the four screws.

Fig. 23: Inserting the IR heat panel

Pay attention to the switch cables when inserting the IR heat panel, and ensure that they are not pinched or damaged.



EN

Insert the IR heat panel into the U-rails. The recess provides the duct for the front heater cable.

4.6. Installing the LED strip**Fig. 24: Attaching the LED strip**

3 screws: 3.5 x 50 mm

Screw the LED cover strip tight from above (pre-drilled)

4.7. Installing the infrared control unit



For installation, commissioning and operation, observe the manual which is included with the control unit. The supplied control unit only supports the “intensity regulation” operating mode.

Connecting the power supply unit

The power supply unit of the control unit is placed under the cabin bench. Guide the mains plug through the opening in the rear wall to the outside, and connect the cables as described below.

Heating group 1: Back heater, IR heat panel (via switch)

Heating group 2: Front heater

Fig. 25: Example for connection

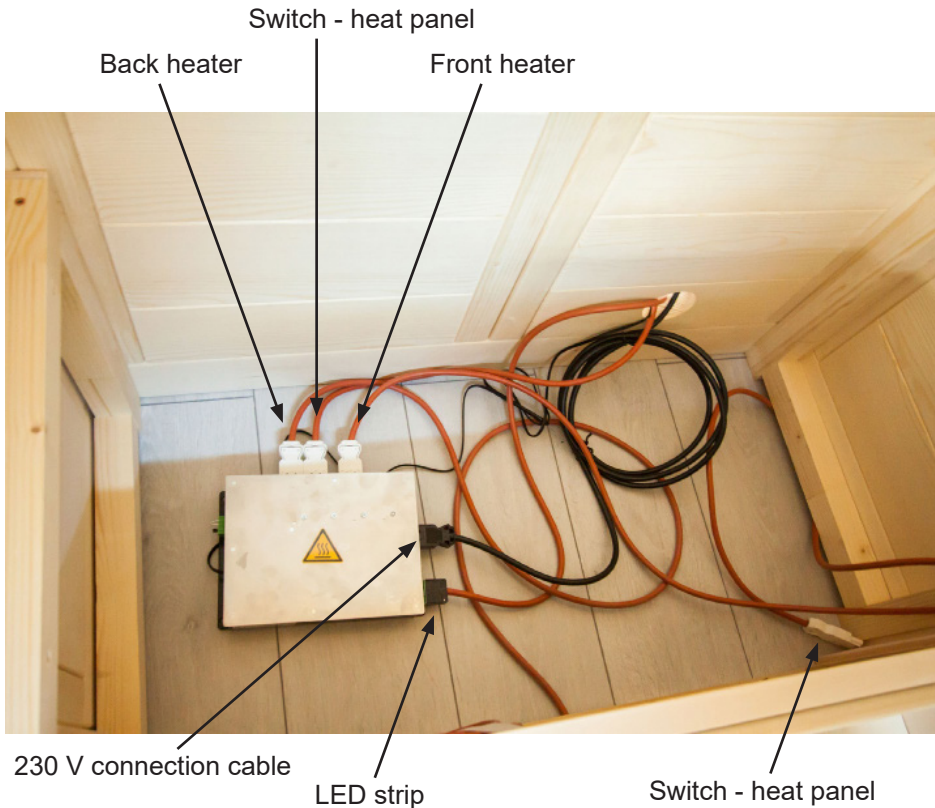
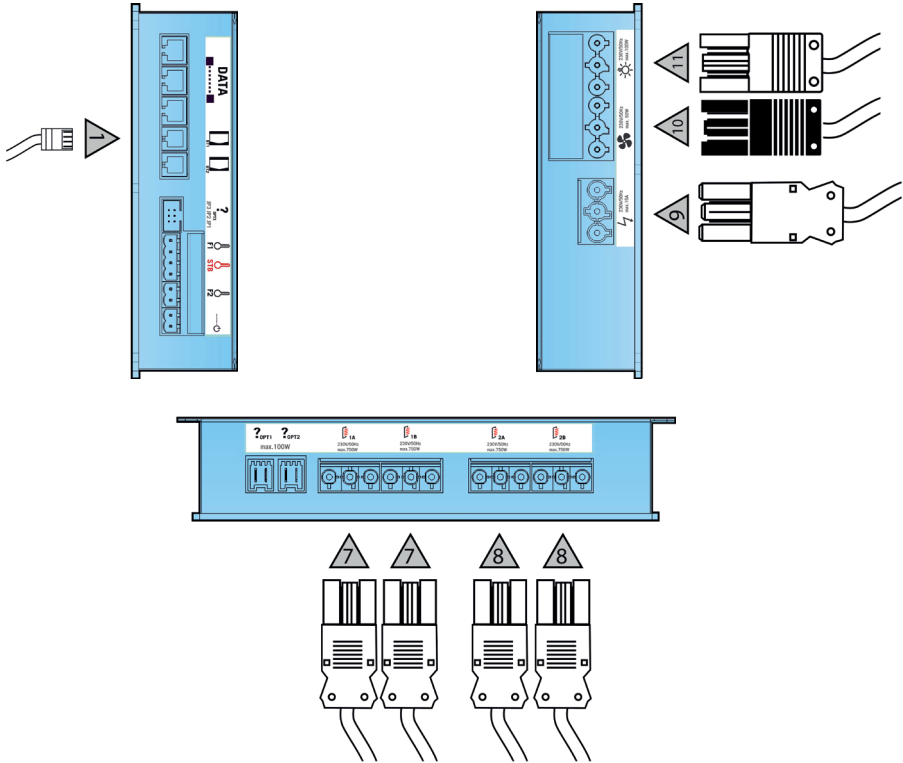

Fig. 26: Connections for power supply unit



EN

<i>Plug</i>	<i>Description</i>
1	wave.com4 infrared operating unit
7	IR heating group 1
8	IR heating group 2
9	Mains connection
10	Fan connection (black) - optional
11	Light connection (green)

Connecting the LED RGBW

Fig. 27: Connecting the LED RGBW to the control unit



Place the LED Dimmer under the bench. Guide the connection cable and the mains plug through the opening in the rear wall.

4.8. Installing the bench

Once the installation of the control unit is completed, the bench can be installed.

Fig. 28: Attaching the bench



2 screws: 4 x 70 mm

Lay the bench on the support slats. Push the seat surface forward.



CAUTION!

Secure the bench against sliding with the lock screws diagonally to the rear wall.

4.9. Installing the backrests and headrests

The frame for the heater is assembled on the back side (pre-drilled) with four 3.5 x 50 mm screws. If this is not possible, fasten with the screws from the front (see image on right).

Screw the Multiclips tight with the aid of the mounting template using the eight 3.5 x 35 mm screws.

Fig. 29: Installing the backrests



Finally, insert the backrests from above down onto the brackets until they latch.

Fig. 30: Installing headrests

4 screws: 3.5 x 35 mm



Screw the brackets tight so they are laterally flush with the backrests. The height can be varied as required. Then insert the headrest into the preferred position.

EN

4.10. Installing the doors

Fig. 31: Installing door fittings 1



EN

Screw the two door fittings tight on the glass door while checking that the alignment of the fittings are straight and that the doors are opened outward.



The alignment of the fittings is achieved by adjusting/rotating the two plastic rings.

Fig. 32: Installing door fittings 2



Fig. 33: Installing door handle

First, place the two silicone inserts in the drill holes for the door handle on the glass element. Afterwards, carefully screw the two handles together.

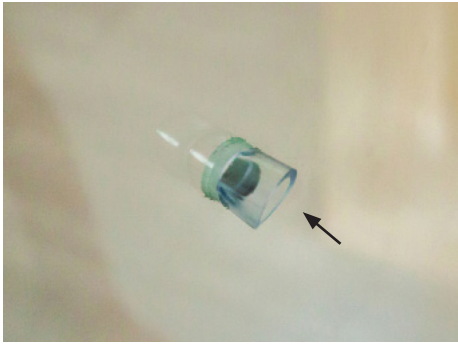

2 screws: 50 x 100 mm

**EN**

The bottom drill hole of the door handle is 92.5 cm high. The door handles are screwed together from the inside.

Fig. 34: Assembly of door magnet

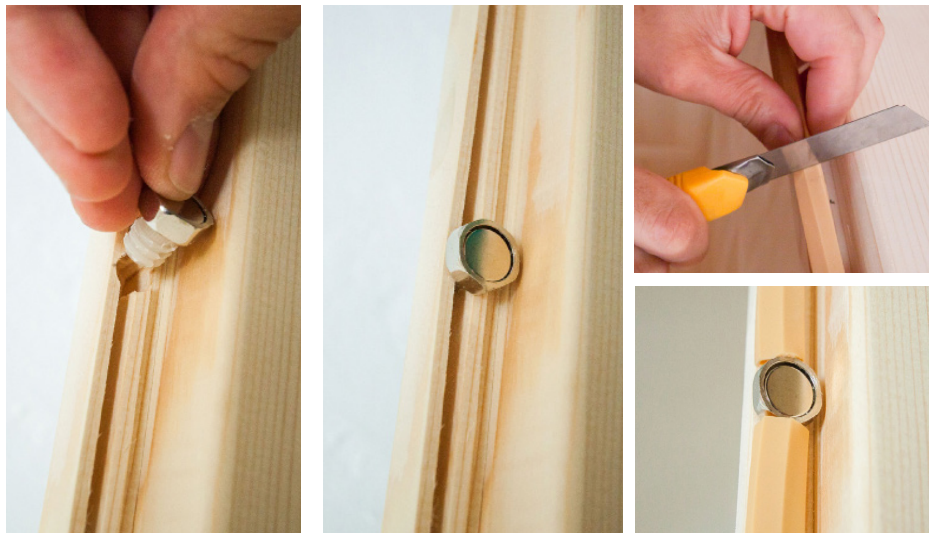

Fig. 35: Assembly of sleeve plate



5. Cleaning and maintenance

5.1. Cleaning

ATTENTION!

Damage to the cabin

- Never pour water on the cabin or the electrical components.
- Do not clean the cabin or the electrical components with too much moisture.

5.2. Maintenance

The MiniMy infrared cabin is maintenance-free.

6. Troubleshooting

- For your own safety, consult your supplier in the event of problems that are not explained in sufficient detail in the installation instructions.

EN

7. Disposal



- Please dispose of packaging materials in accordance with the applicable disposal regulations.
- Used units contain reusable materials as well as hazardous substances. Therefore, do not dispose of your used unit with household waste, but rather do so in accordance with the locally applicable regulations.

8. Technical data

Ambient conditions

Storage temperature:	- 25 °C to + 70 °C
Ambient temperature:	20 °C to + 30 °C
Relative humidity:	max. 95%

9. Floor plan

Since wood is a natural product, minor deviations in the dimensions can occur.

9.1. “Left-hand door” floor plan

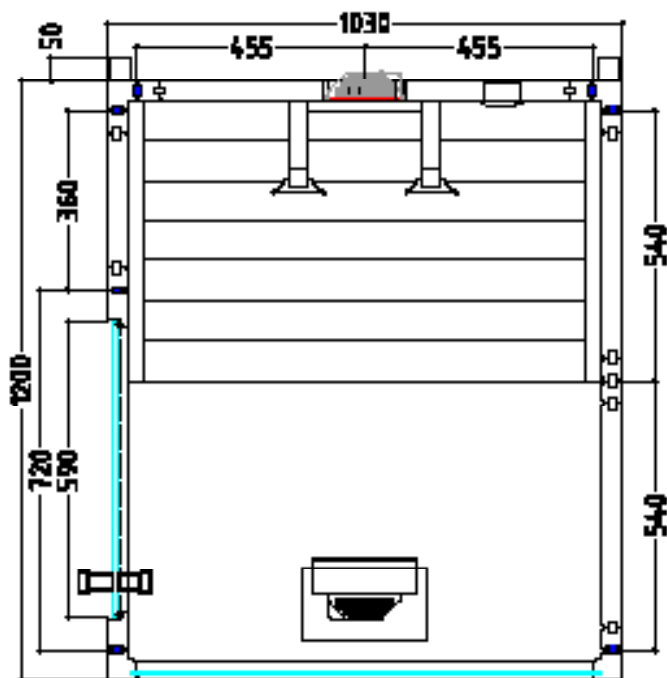

9.2. "Right-hand door" floor plan

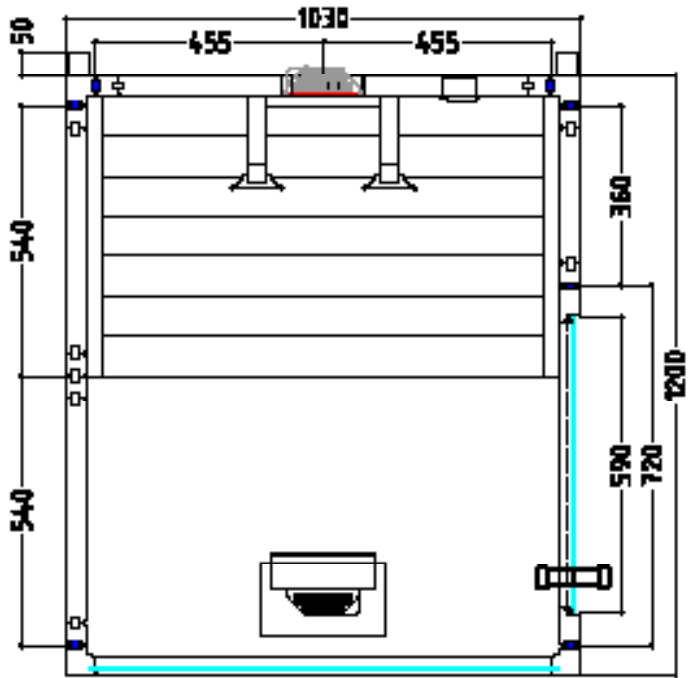

9.3. Changes for installation with “right-hand door” floor plan

For the installation of the glass element (Page 16)

Remove the Multiclips on the glass element and assemble them with the aid of the supplied template at the position indicated.

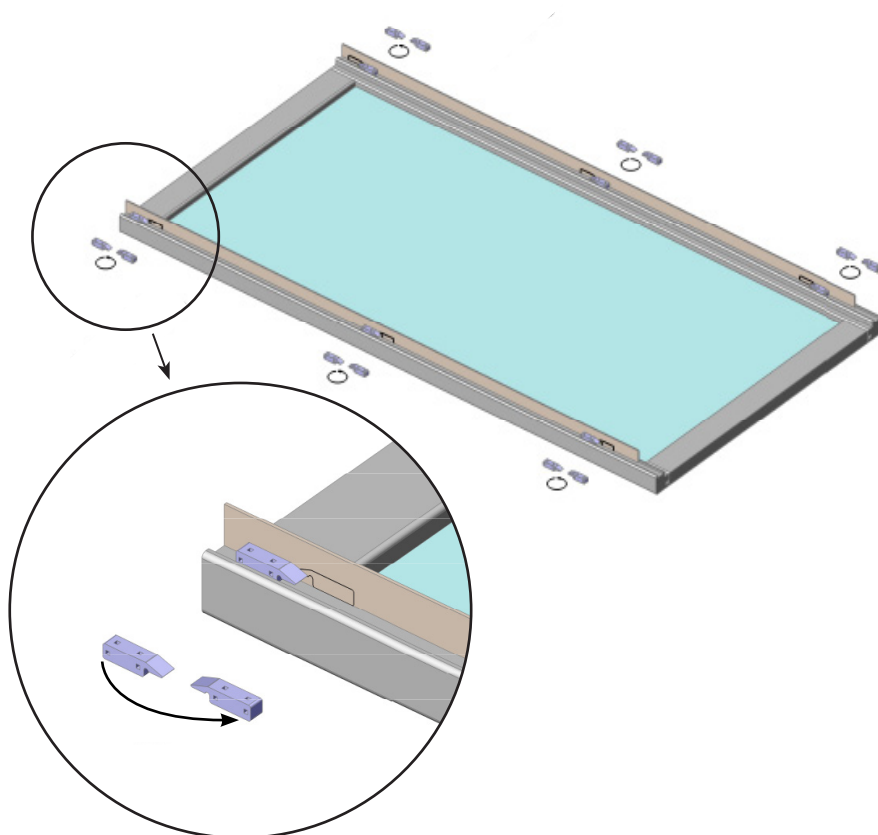
**EN**

Harvia MiniMy 120 Basic

HARVIA

Infrarotkabine

Gebrauchs- und Montageanweisung

120 x 130 x 202 cm

Artikel Nr.

MINIMY-120-B



DE



CE UK
CA

Inhaltsverzeichnis

1. Zu dieser Anleitung	3
2. Wichtige Hinweise zu Ihrer Sicherheit	4
2.1. Bestimmungsgemäßer Gebrauch	4
2.2. Sicherheitshinweise	4
3. Produktbeschreibung	6
3.1. Lieferumfang MiniMy	6
3.2. Produktfunktionen	6
4. Montage der Infrarotkabine MiniMy	7
4.1. Benötigtes Werkzeug	7
4.2. Stückliste Infrarotkabine MiniMy	8
4.3. Montage der Kabine	10
4.4. Montage der Inneneinrichtung	20
4.5. Montage Infrarot-Strahler und Wärmeplatte	21
4.6. Montage der LED-Leiste	23
4.7. Installation der Infrarot-Steuerung	24
4.8. Montage der Bank	27
4.9. Montage der Rückenlehnen und Kopfstützen	28
4.10. Montage der Türe	30
5. Reinigung und Wartung	33
5.1. Reinigung	33
5.2. Wartung	33
6. Problemlösung	33
7. Entsorgung	33
8. Technische Daten	34
9. Grundriss	34
9.1. Grundriss „Tür links“	34
9.2. Grundriss „Tür rechts“	35
9.3. Änderungen bei Montage Grundriss „Tür rechts“	36

1. Zu dieser Anleitung

Lesen Sie diese Montage- und Gebrauchsanweisung gut durch und bewahren Sie sie in der Nähe der Infrarotkabine auf. So können Sie jederzeit Informationen zu Ihrer Sicherheit und zur Bedienung nachlesen.



Sie finden diese Montage- und Gebrauchsanweisung auch im Downloadbereich unserer Webseite auf www.mediabank.harvia.com.

Symbole in Warnhinweisen

In dieser Montage- und Gebrauchsanweisung ist vor Tätigkeiten, von denen eine Gefahr ausgeht, ein Warnhinweis angebracht. Befolgen Sie diese Warnhinweise unbedingt. So vermeiden Sie Sachschäden und Verletzungen, die im schlimmsten Fall sogar tödlich sein können.

In den Warnhinweisen werden Signalwörter verwendet, die folgende Bedeutungen haben:



GEFAHR!

Wenn Sie diesen Warnhinweis nicht beachten, sind Tod oder schwere Verletzungen die Folge.



WARNUNG!

Wenn Sie diesen Warnhinweis nicht beachten, können Tod oder schwere Verletzungen die Folge sein.



VORSICHT!

Wenn Sie diesen Warnhinweis nicht befolgen, können leichte Verletzungen die Folge sein.

ACHTUNG!

Dieses Signalwort warnt Sie vor Sachschäden.

Andere Symbole



Dieses Symbol kennzeichnet Tipps und nützliche Hinweise.



Nicht abdecken!

2. Wichtige Hinweise zu Ihrer Sicherheit

Die Infrarotkabine ist nach anerkannten sicherheitstechnischen Regeln gebaut. Dennoch können bei der Verwendung Gefahren entstehen. Befolgen Sie deshalb die folgenden Sicherheitshinweise und die speziellen Warnhinweise in den einzelnen Kapiteln.

2.1. Bestimmungsgemäßer Gebrauch

Die Infrarotkabine dient zur Erwärmung des menschlichen Körpers.

Der Standort der Kabine muss vor Spritzwasser geschützt sein. Für einen optimalen Betrieb sollte der Standort eine Umgebungstemperatur von mindestens 20 °C aufweisen. Die maximale Umgebungsluftfeuchte sollte 95% nicht überschreiten.

DE

Die Kabine muss auf einer ebenen Fläche aufgestellt werden. Es muss ein Wandabstand von mindestens 5 cm eingehalten werden.

Jeder darüber hinausgehende Gebrauch gilt als nicht bestimmungsgemäß. Nicht bestimmungsgemäßer Gebrauch kann zur Beschädigung des Produkts, zu schweren Verletzungen oder Tod führen.

2.2. Sicherheitshinweise

- Montage- und Anschlussarbeiten an elektrischen Teilen (Steuerung, Strahler,...) dürfen nur im spannungsfreien Zustand durchgeführt werden.
- Beachten Sie auch die örtlichen Bestimmungen am Aufstellort.
- Bei Problemen, die in den Montageanweisungen nicht ausführlich genug behandelt werden, wenden Sie sich zu Ihrer eigenen Sicherheit an Ihren Lieferanten.

- Die Kabine darf nicht von Kindern unter 8 Jahren verwendet werden.
- Die Kabine darf von Kindern über 8 Jahren, von Personen mit verringerten psychischen, sensorischen oder mentalen Fähigkeiten und von Personen mit Mangel an Erfahrung und Wissen unter folgenden Bedingungen verwendet werden:
 - wenn sie beaufsichtigt werden.
 - wenn ihnen die sichere Verwendung gezeigt wurde und sie die Gefahren, die entstehen können, verstehen.
- Kinder dürfen nicht mit der Kabine spielen.
- Kinder unter 14 Jahren dürfen die Kabine nur reinigen, wenn sie beaufsichtigt werden.
- Die Kabine darf nicht mit Dampfreinigern, Hochdruckreinigern oder Spritzwasser gereinigt werden.
- Wenn Sie unter dem Einfluss von Alkohol, Medikamenten oder Drogen stehen, verzichten Sie aus gesundheitlichen Gründen auf das Saunabad.
- Stellen Sie sicher, dass keine brennbaren Gegenstände auf den Heizelementen liegen, bevor Sie die Steuerung einschalten.

3. Produktbeschreibung

3.1. Lieferumfang MiniMy

- 1x 1-045-570 / Infrarotkabine MiniMy
- 1x 1-037-357 / Leistungsteil wave.com4 Infra für VitaMy
- 1x 1-012-222 / Bedienteil wave.com4 Infra
- 1x 1-009-265 / Netzanschlussleitung Infrarot 2,5m
- 1x 1-027-788 / Infrarotstrahler ECO 500 - dunkel (vormontiert)-Frontstrahler
- 1x 1-027-785 / Infrarotstrahler ECO 350 - dunkel - Rückenstrahler
- 1x 1-028-348 / IR- Wärmeplatte 380mm x 700mm, 230V/100W (vormontiert)
- 1x 1-037-397 / Schalter-Set IR-Wärmeplatte (vormontiert)
- 1x 1-028-660 / Entlüftung Rund Espe 631-A
- 1x 1-028-629 / Specksteinschale
- 1x 1-052-935/ LED-Set WC4-Infra

DE

3.2. Produktfunktionen

Infrarotkabine

Massivkabine aus Fichtenholz für die Infrarotbestrahlung von 1 Person.



Harzgallen sind kein Reklamationsgrund. Da in Fichtenholz immer wieder Harzgallen vorkommen und man beim Aussortieren nicht erkennen kann in welcher Tiefe diese sich befinden.

Wenn diese knapp unter der Oberfläche sind brechen sie bei Hitzeentwicklung auf und „bluten“ aus.

Das ausgelaufene Harz kann man mit einem Aceton gedrängtem Lappen entfernen. Wenn lediglich Harztropfen entstehen, lassen Sie diese aushärten und schaben sie anschließend mit einem Messer vorsichtig ab.

Infrarotsteuerung wave.com4 Infra

Steuerung zum Dimmen von 2 Heizkreisen mit je maximal 1,5 kW und zum Dimmen von Licht und einem optionalen Lüfter.



Diese Steuerung unterstützt lediglich die Betriebsart „Intensitätsregelung“.

4. Montage der Infrarotkabine MiniMy

Kontrollieren Sie, bevor Sie mit der Arbeit beginnen, anhand der Stückliste, ob alle Einzelteile auch tatsächlich mitgeliefert wurden. Sollten Einzelteile ausnahmsweise fehlen, benachrichtigen Sie spätestens 14 Tage nach Erhalt der Kabine Ihren Händler.



Für die Montage benötigen Sie einen Helfer!

Weiters empfehlen wir die Löcher für die Schrauben vorzubohren.

4.1. Benötigtes Werkzeug

- Hammer und Beilageholz oder einen Gummihammer
- Akkuschauber mit Bits für Kreuzschrauben und Torx
- Rollmaßband
- Wasserwaage
- Durchschlag oder Holzklötzchen 12 mm
- Imbus 1,5 mm



Vorbohren



Überprüfung des rechten Winkel:

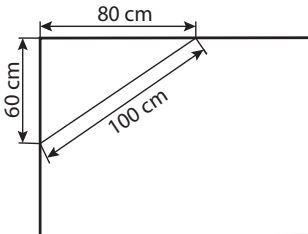

Vorsichtiger Umgang mit Glas: Besondere Vorsicht gilt den Glaskanten - Gehärtetes Glas kann bei Stößen in kleine Scherben zerspringen. Legen Sie ein Schutzpolster (z.Bsp.: Verpackungs-Karton) unter die Glaskante.

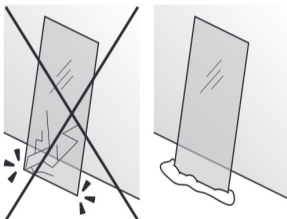

4.2. Stückliste Infrarotkabine MiniMy

Az	Bezeichnung	Maß
Bodenrahmen		
1	Bodenrahmen hinten	103 x 9 x 4 cm
1	Bodenrahmen rechts	114 x 9 x 4 cm
1	Bodenrahmen links	42 x 9 x 4 cm
Wandelemente		
2	Wandelement A/A mit Multiclip	193 x 54 x 4 cm
1	Wandelement A/A mit Multiclip	193 x 36 x 4 cm
1	Wandelement A/B mit Strahlerausschnitt	193 x 45,5 x 4 cm
1	Wandelement A/B mit Strahler- u. Bedienteil-ausschnitt	193 x 45,5 x 4 cm
1	Glaselement mit Multiclip	202 x 103 x 4 cm
1	Türrahmen	202 x 72 x 4 cm
Dachelemente		
1	Dachelement A/B mit Ausschnitt Lüfter	107 x 45 x 4 cm
1	Dachelement A/B	107 x 45 x 4 cm
Ecksteher		
2	Ecksteher 90°	193 x 6 x 6 cm
Auflageleisten		
1	Dachauflageleiste	112 x 4 x 4 cm
1	Dachauflageleiste mit Bohrung	112 x 4 x 4 cm
1	Dachauflageleiste	95 x 4 x 4 cm
1	Dachauflageleiste mit Bohrung	95 x 4 x 4 cm
1	Bankauflage links	41 x 56 x 4 cm
1	Bankauflage rechts	41 x 56 x 4 cm

Az	Bezeichnung	Maß
Inneneinrichtung		
1	Strahlerkasten Fichte	105 x 23 x 12 cm
1	IR-Wärmeplatte inkl. Gitter	79,8 x 42 x 4,5 cm
1	Bank	94,5 x 56 x 10 cm
2	Ergo-Rückenlehne	70 x 18 x 10,5 cm
1	Kopfstütze VitaMy	35 x 27,5 x 8 cm
1	Rahmen für Strahler 350W Linde	73,5 x 23 x 2 cm
1	LED Abdeckleiste	95 x 3 x 3 cm
1	Boden Fichte	94,4 x 61,8 x 4 cm
Glaselement		
1	Glastür	191,5 x 59 x 0,8 cm
Zubehör		
1	Türgriff Set Holz/Holz	
1	Türmagnet, Überschubblech	
1	2 Türbänder 8653-02	
2	Montageleiste für Kopfstütze	13,5 x 2 x 2 cm
1	Schablone für Multiclip Montage Rückenlehne	
1	Schablone für Multiclip Montage Glasfront	
2	Abstandsleiste Rückwand	202 x 5 x 4 cm
1	Montagematerial	
1	Montageanleitung	

4.3. Montage der Kabine

Die Kabine kann „Tür links“ oder „Tür rechts“ aufgebaut werden, beachten Sie dazu die Grundrisspläne auf Seite 34 und Seite 35.

Montage des Bodenrahmens

Abb. 1: Auflegen der drei Bodenrahmen-Elemente



Abb. 2: Bodenrahmen verbinden

Schlagen Sie die Kunststoffschalben vorsichtig mit einem Hammer, an den beiden Ecken des Bodenrahmens ein, bis diese bündig mit der Nut des Elements sind. Verwenden Sie einen Durchschlag oder ein Holzklötzchen, damit die Kunststoffschalbe gut versenkbar ist.

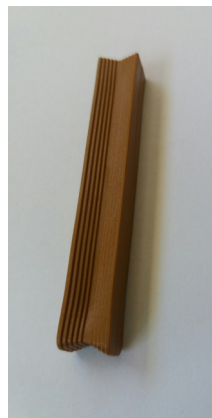
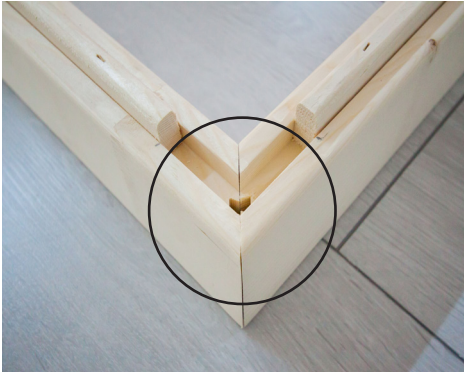

DE

Montage der Wandelemente

Die Ecksteher werden mittels „Multiclips“ mit den Wandelementen verbunden. Die weiteren Wandelemente sind mit Nut und Feder verbunden und werden miteinander verschraubt.

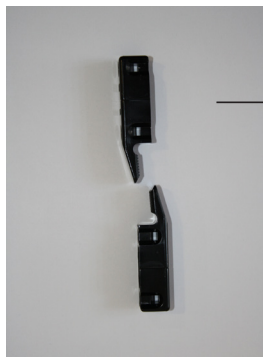
Abb. 3: Multiclips

Ecksteher

Achtung!

In weiterer Folge wird die Montage für Grundriss „Tür links“ beschrieben.
 Änderungen betreffend Montage für Grundriss „Tür rechts“ - siehe Seite 35.



A bezeichnet immer die Sichtseite, dies ist auf der Oberseite der Wandelemente gekennzeichnet.

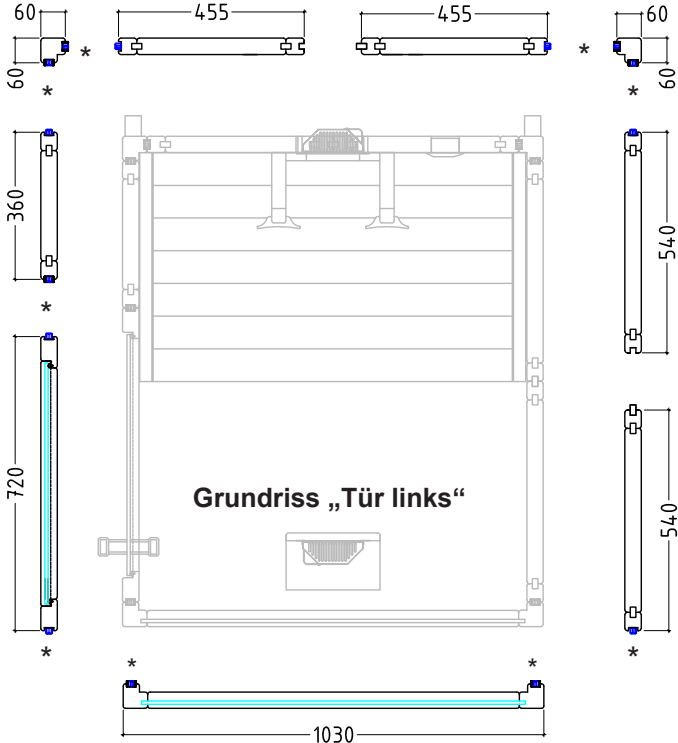

* Multiclips

DE

Abb. 4: Wandelemente mit Ecksteher verbinden

Stecken Sie den Ecksteher von oben nach unten auf die Wandelemente. Achten Sie dabei auf die korrekte Ausrichtung der „Multiclips“ (siehe Abb. 4). Der Ecksteher muss bündig mit den Wandelementen sein.

Abb. 5: Montage auf Bodenrahmen

Abb. 6: Wandelement mit Ausschnitt einsetzen**DE**

Nachdem Sie das Strahlerelement eingesetzt haben, fahren Sie mit der zweiten Ecke fort.

Abb. 7: Fertig montierte Wandelemente

Abb. 8: Verschrauben der Wandelemente

Überprüfen Sie die rechten Winkel, bevor Sie die Wandelemente verschrauben. Beachten Sie den Tipp auf Seite 8.



DE

Bohrer 3 mm, 2 Stk. Schrauben 4 x 70 mm



Abb. 9: Montage des Glaselements



DE

Abb. 10: Montage des Türrahmens

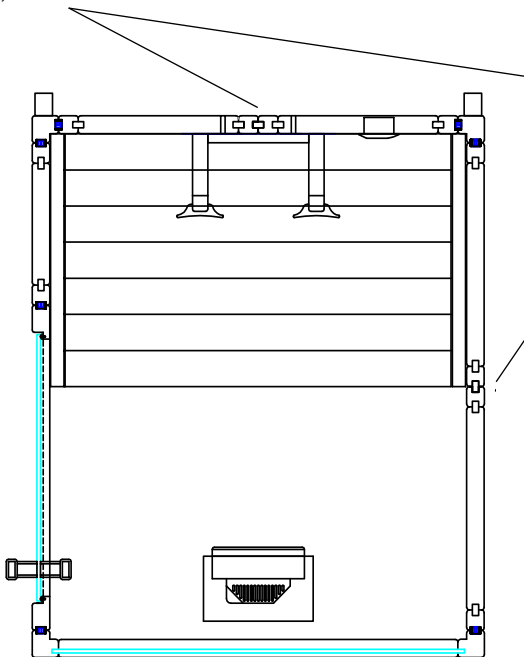

Montage der Dachelemente



Überprüfen Sie die rechten Winkel, bevor Sie die Wandelemente verschrauben. Beachten Sie den Tipp auf Seite 8.

Abb. 11: Montage Dachauflageleisten

Schrauben Sie die Dachauflageleisten wie in Abb. 11 an allen Wänden der Kabine fest. Achten Sie dabei auf einen bündigen Abschluss von Wandelementen und Dachauflageleiste.



16 Stk Schrauben: 3,5 x 50 mm

Position Leiste mit Bohrung

DE

Abb. 12: Dachauflageleisten



Abb. 13: Einlegen Dachelement hinten mit Lüfterausschnitt



Abb. 14: Einlegen Dachelemente vorne

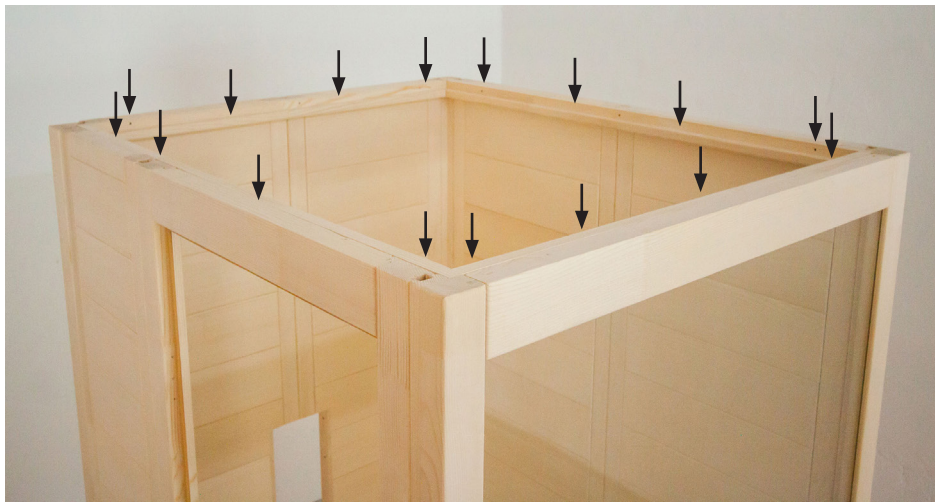

DE

Abb. 15: Befestigen der Dachelemente

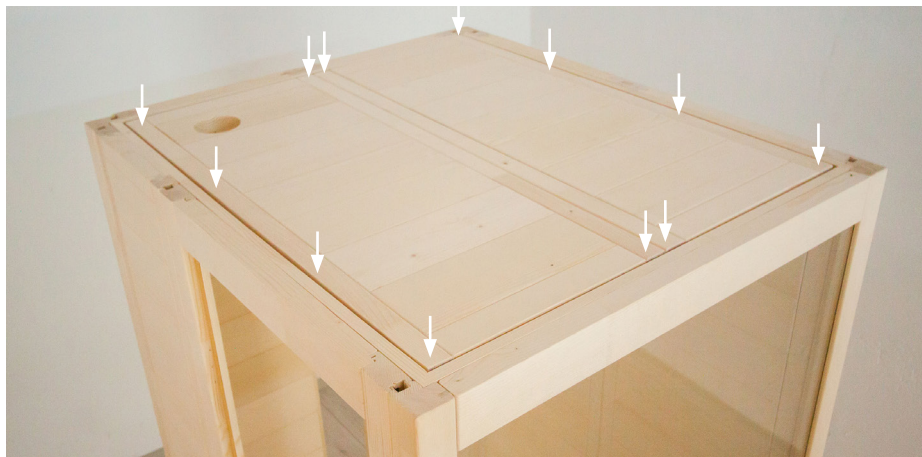

12 Stk Schrauben: 3,5 x 35 mm

Abb. 16: Montage Abstandleisten Rückwand

Schrauben Sie die Abstandleisten an der Rückwand fest, wahlweise bündig oder bis zu 10 cm nach innen versetzt.

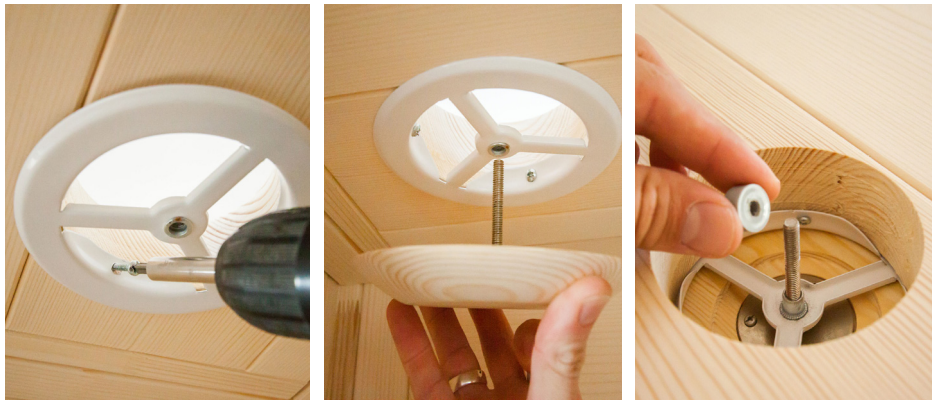

Schrauben 4 Stk: 4 x 70

Montage der Entlüftung**Abb. 17: Montage der Entlüftung**

Schrauben Sie das Basiselement der Entlüftung mit den 3 beiliegenden Schrauben fest. Schrauben Sie anschließend das Holztafel ein und sichern Sie die Schraube von außen mit der Kunststoffkappe.

4.4. Montage der Inneneinrichtung

Abb. 18: Bankauflagen montieren



4 Stk Schrauben: 4 x 70 mm

4 Stk Schrauben: 4 x 70 mm

Abb. 19: Fußboden einlegen

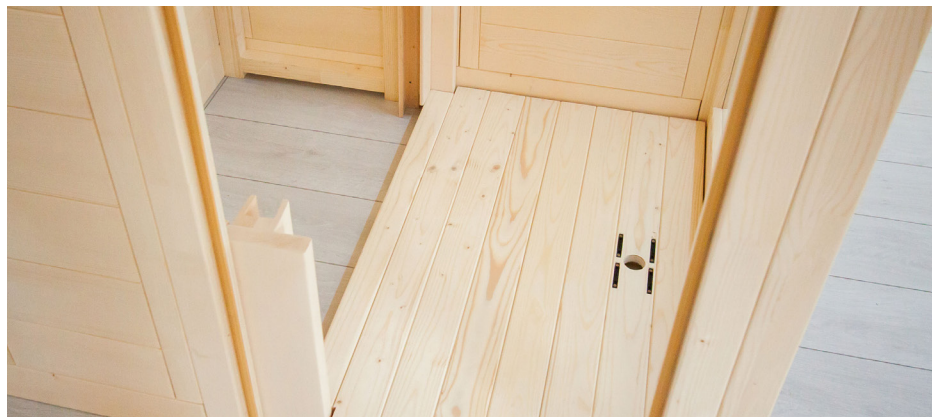

4.5. Montage Infrarot-Strahler und Wärmeplatte

Abb. 20: Frontstrahler fixieren



Achten Sie darauf, dass die Kabel der Frontstrahler frei am Boden liegen und nicht durch den Kabinenboden eingeklemmt oder beschädigt werden.

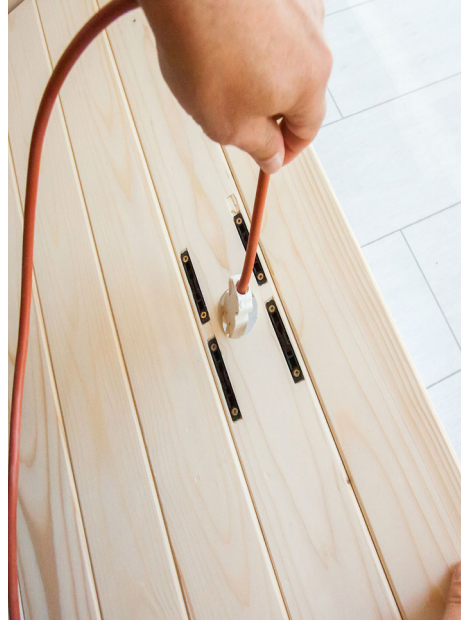

Nachdem der Strahler am Boden eingerastet ist, fixieren Sie diesen mit einer Drehung um 90° an den Imbusschrauben im Uhrzeigersinn an den vier Befestigungspunkten.

Abb. 22: Einlegen der Specksteinschale**Abb. 21: Rückenstrahler (Infrarot-Strahler ECO 350) montieren****VORSICHT!**

Achten Sie darauf, dass der Anschlusskasten der Strahler auf der Oberseite ist!

DE

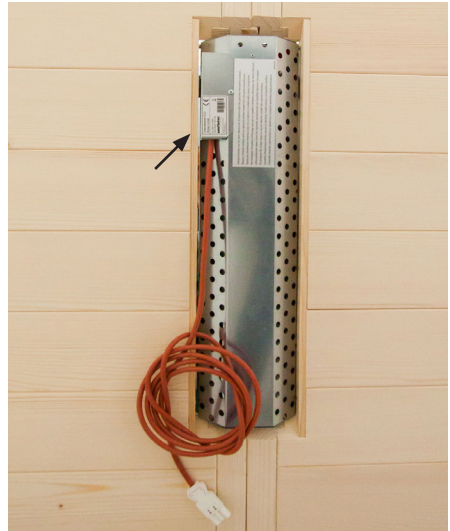

Schrauben 4 Stk: 3 x 18 mm

Setzen Sie den Strahler von innen in den Ausschnitt ein. Schrauben Sie den Strahler mit 4 Schrauben fest.

Abb. 23: Einsetzen der IR-Wärmeplatte

Achten Sie beim Einsetzen der IR-Wärmeplatte auf die Kabel der Schalter, diese dürfen nicht eingeklemmt oder beschädigt werden.



DE

Setzen Sie die IR-Wärmeplatte in die U-Leisten ein. Die Ausnehmung dient zur Durchführung der Leitung des Frontstrahles.

4.6. Montage der LED-Leiste**Abb. 24: LED-Leiste fixieren**

Schrauben 3 Stk: 3,5 x 50 mm

Schrauben Sie die LED Abdeckleiste von oben fest (vorgebohrt)

4.7. Installation der Infrarot-Steuerung



Beachten Sie für die Montage, Inbetriebnahme und Bedienung die Anleitung, welche der Steuerung beiliegt. Von der beiliegenden Steuerung wird lediglich die Betriebsart „Intensitätsregelung“ unterstützt.

Anschluss des Leistungsteils

Das Leistungsteil der Steuerung wird unter der Bank der Kabine platziert. Führen Sie den Netzstecker durch die Öffnung in der Rückwand nach außen und schließen Sie die Leitungen wie folgt an.

Heizgruppe 1: Rückenstrahler, IR-Wärmeplatte (über Schalter)

Heizgruppe 2: Frontstrahler

Abb. 25: Beispiel für Anschluss



Abb. 26: Anschlüsse Leistungsteil



DE

Stecker	Beschreibung
1	wave.com4 Infra Bedienteil
7	IR-Heizgruppe 1
8	IR-Heizgruppe 2
9	Netzanschluss
10	Lüfteranschluss (schwarz) - optional
11	Lichtanschluss (grün)

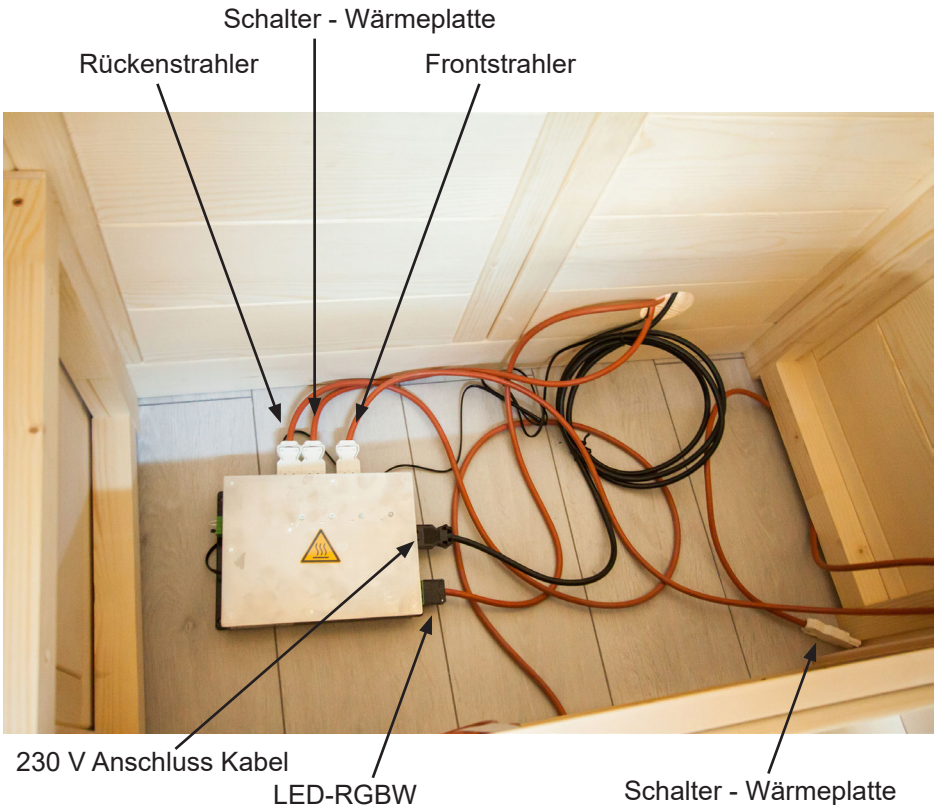
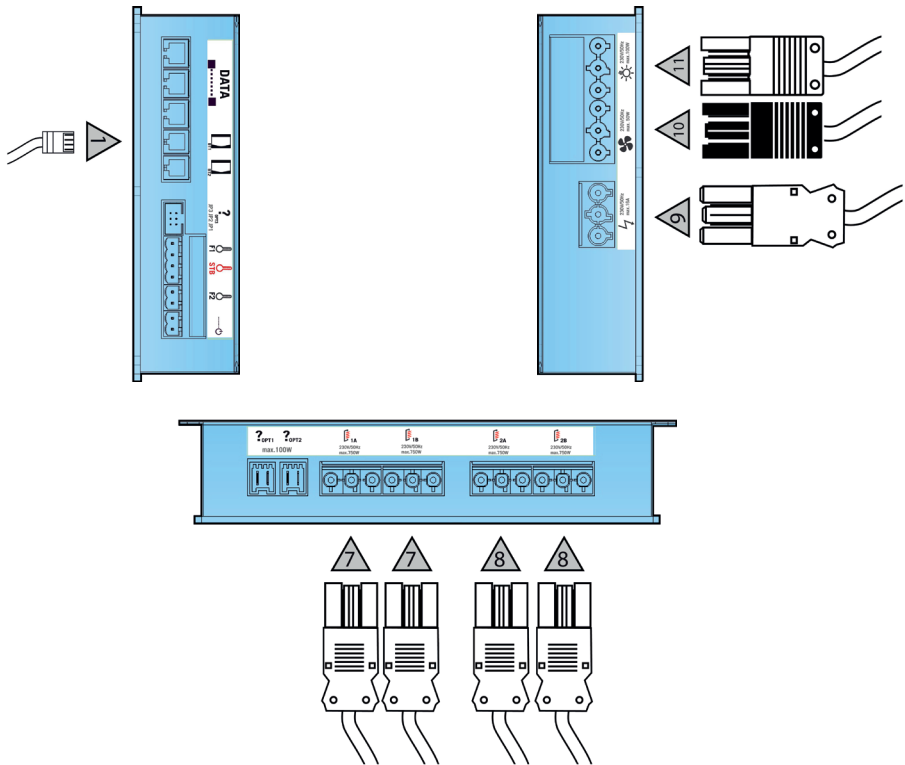
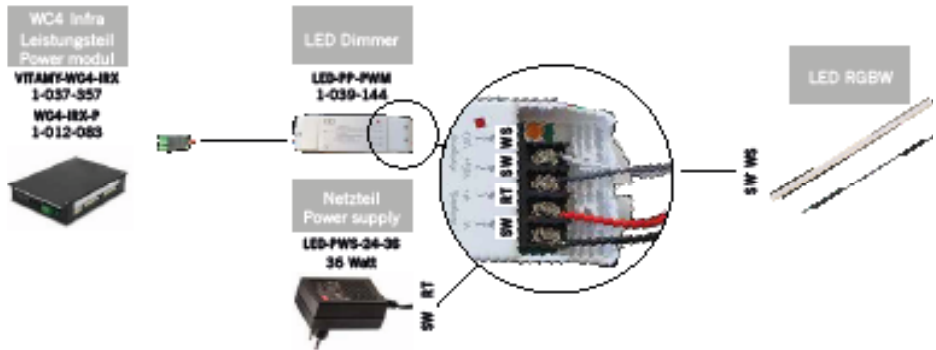
Anschluss des LED RGBW**Abb. 27: Verbinden des LED RGBW mit der Steuerung**

Geben Sie den LED Dimmer unter die Bank. Führen Sie die Anschlussleitung und den Netzstecker durch die Öffnung in der Rückwand.

4.8. Montage der Bank

Nachdem die Steuerung fertig angeschlossen ist, kann die Bank fertig montiert werden.

Abb. 28: Fixieren der Sitzbank



2 Stk Schrauben: 4 x 70 mm

Legen Sie die Bank auf die Auflageleisten. Schieben Sie die Sitzflächen nach vorne.



VORSICHT!

Sichern Sie die Bank gegen Verrutschen mit den Sicherungsschrauben schräg gegen die Rückwand.

4.9. Montage der Rückenlehnen und Kopfstützen

Die Montage des Rahmens für den Strahler erfolgt von der Rückseite (vorgebohrt) mit 4 Stk. Schrauben 3,5 x 50 mm. Sollte dies nicht möglich sein, befestigen Sie diesen mit den Schrauben von vorne (siehe Bild rechts).

Schrauben Sie die Multiclips mit Hilfe der Montageschablone mit den 8 Stk. Schrauben 3,5 x 35 mm fest.

Abb. 29: Montage Rückenlehnen



Stecken Sie abschließend die Rückenlehnen von oben nach unten auf die Halterungen bis diese einrasten.

Abb. 30: Montage Kopfstützen

4 Stk Schrauben: 3,5 x 35 mm



Schrauben Sie die Halterungen seitlich bündig mit den Rückenlehnen fest. Die Höhe kann je nach Wunsch variiert werden. Stecken Sie anschließend die Kopfstütze an die gewünschte Position.

DE



4.10. Montage der Türe

Abb. 31: Montage Türbeschläge 1



DE

Schrauben Sie die beiden Türbeschläge an der Glastür fest, achten sie dabei auf die gerade Ausrichtung der Beschläge und darauf, dass die Öffnung der Türe nach außen erfolgt.



Die Ausrichtung der Beschläge wird durch die Justierung / Drehung der beiden Kunststoffringe vorgenommen.

Abb. 32: Montage Türbeschläge 2



Abb. 33: Montage Türgriff

Setzen Sie zuerst die beiden Silikoneinlagen in die Bohrungen für den Türgriff am Glaselement ein. Danach verschrauben Sie die beiden Griffe vorsichtig miteinander.

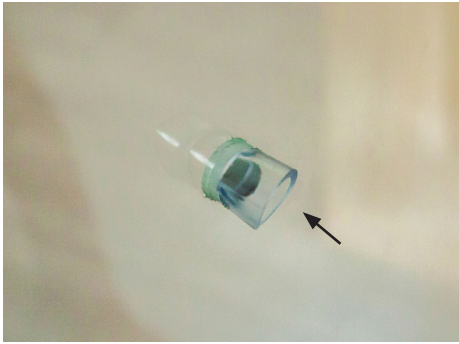

2 Stk Schrauben: 5 x 100 mm



DE

Die untere Bohrung des Türgriffs ist in 92,5 cm Höhe. Die Türgriffe werden von innen miteinander verschraubt.

Abb. 34: Montage Türmagnet

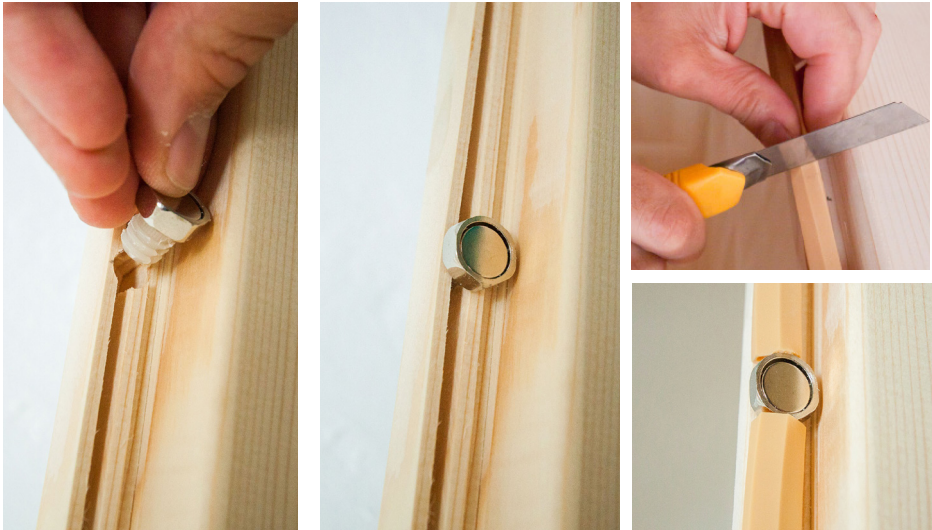

DE

Abb. 35: Montage Überschub-Blech



5. Reinigung und Wartung

5.1. Reinigung

ACHTUNG!

Schäden an der Kabine

- Übergießen Sie die Kabine und die elektronischen Komponenten nicht mit Wasser.
- Reinigen Sie die Kabine und die elektronischen Komponenten nicht zu feucht.

5.2. Wartung

Die Infrarotkabine MiniMy ist wartungsfrei.

6. Problemlösung

- Bei Problemen, die in den Montageanweisungen nicht ausführlich genug behandelt werden, wenden Sie sich zu Ihrer eigenen Sicherheit an Ihren Lieferanten.

DE

7. Entsorgung



- Entsorgen Sie die Verpackungsmaterialien nach den gültigen Entsorgungsrichtlinien.
- Altgeräte enthalten wiederverwendbare Materialien, aber auch schädliche Stoffe. Geben Sie Ihr Altgerät deshalb auf keinen Fall in den Restmüll, sondern entsorgen Sie das Gerät nach den örtlich geltenden Vorschriften.

8. Technische Daten

Umgebungsbedingungen

Lagertemperatur:	- 25 °C bis + 70 °C
Umgebungstemperatur:	20 °C bis + 30 °C
Luftfeuchtigkeit:	max. 95%

9. Grundriss

Da Holz ein Naturprodukt ist, sind geringfügige Maßabweichungen möglich.

9.1. Grundriss „Tür links“

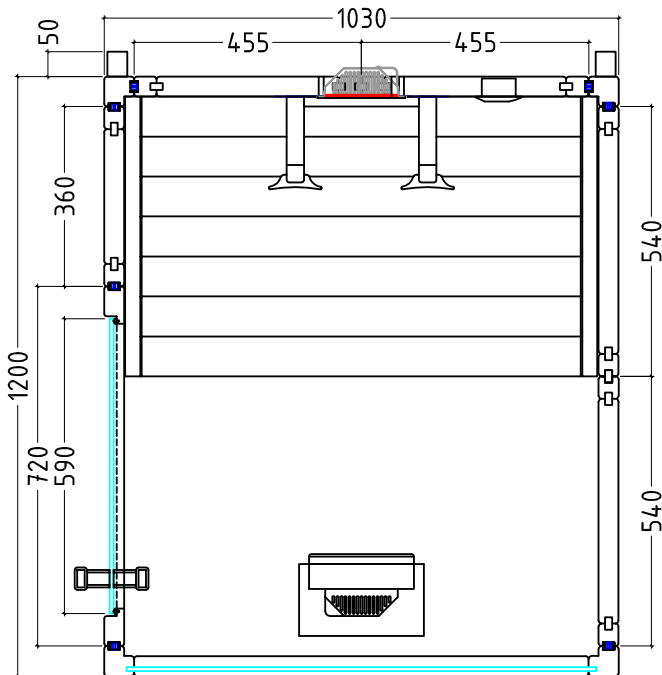

9.2. Grundriss „Tür rechts“

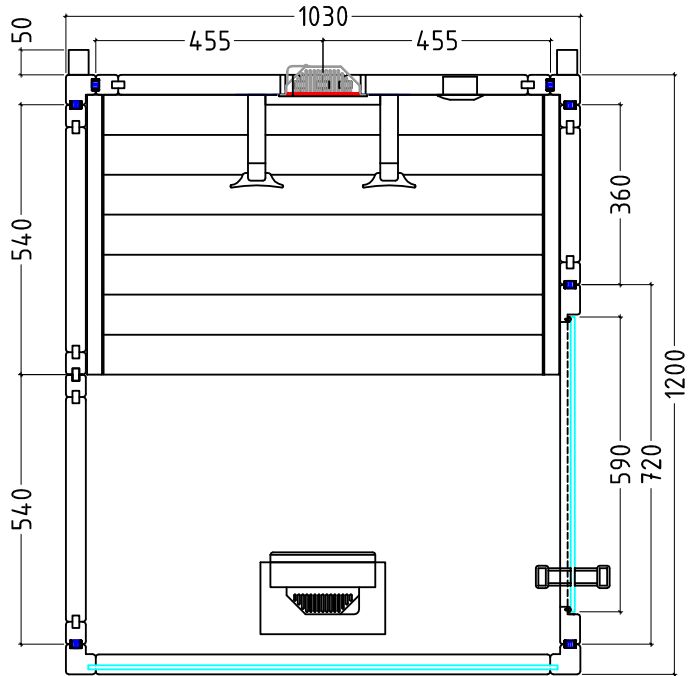

9.3. Änderungen bei Montage Grundriss „Tür rechts“

Für die Montage des Glaselementes (Seite 16)

Entfernen Sie die Multiclips beim Glaselement und montieren Sie diese mit Hilfe der beiliegenden Schablonen an gekennzeichnetener Position.



DE

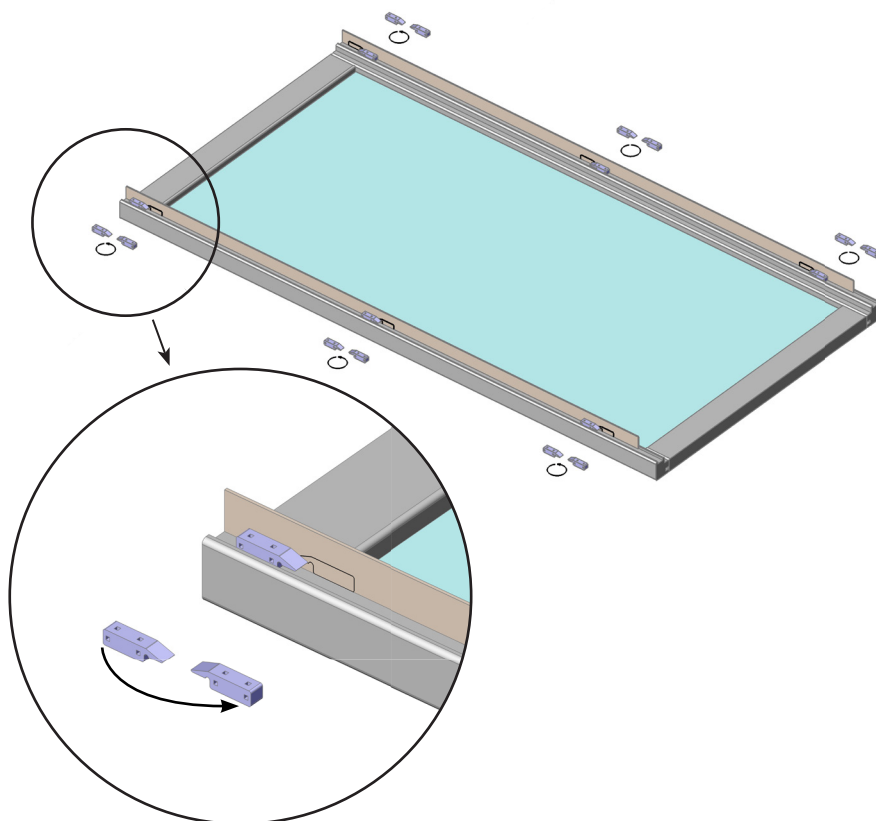

Harvia MiniMy 120 Basic

HARVIA

Cabine infrarouge

Instructions de montage et mode d'emploi

120 x 130 x 202 cm

Réf.

MINIMY-120-B



FR



**CE UK
CA**

Table des matières

1. Concernant ces instructions	3
2. Remarques importantes pour votre sécurité	4
2.1. Usage conforme	4
2.2. Consignes de sécurité	4
3. Description du produit	6
3.1. Étendue de la livraison MiniMy	6
3.2. Fonctions du produit	6
4. Montage de la cabine infrarouge MiniMy	7
4.1. Outils requis	7
4.2. Liste des pièces cabine infrarouge MiniMy	8
4.3. Montage de la cabine	10
4.4. Montage de l'équipement intérieur	20
4.5. Montage des radiateurs infrarouge et de la plaque chauffante	21
4.6. Montage de la barre à LED	23
4.7. Montage de la commande infrarouge	24
4.8. Montage du banc	27
4.9. Montage des dossiers et des appui-têtes	28
4.10. Montage des portes	30
5. Nettoyage et entretien	33
5.1. Nettoyage	33
5.2. Entretien	33
6. Dépannage	33
7. Élimination	33
8. Caractéristiques techniques	34
9. Plan	34
9.1. Plan « Porte à gauche »	34
9.2. Plan « Porte à droite »	35
9.3. Modifications lors du montage selon le plan « Porte à droite »	36

1. Concernant ces instructions

Lisez attentivement ces instructions de montage et ce mode d'emploi et conservez-les à proximité de la cabine infrarouge. Vous pouvez ainsi consulter à tout moment des informations concernant son utilisation et relatives à votre sécurité.



Ces instructions de montage et ce mode d'emploi sont également disponibles dans la rubrique de téléchargement de notre site Internet www.mediabank.harvia.com.

Symboles d'avertissement

Dans les instructions de montage et le mode d'emploi, un avertissement précède les activités représentant un danger. Conformez-vous impérativement à ces avertissements. Vous éviterez ainsi des dommages matériels et des blessures qui, dans le pire des cas, peuvent être mortelles.

Ces avertissements utilisent des termes clés qui ont la signification suivante :



DANGER !

Si vous ne respectez pas cet avertissement, il y a un risque de blessures graves, voire mortelles.



AVERTISSEMENT !

Si vous ne respectez pas cet avertissement, il y a un risque éventuel de blessures graves, voire mortelles.



PRUDENCE !

Si vous ne respectez pas cet avertissement, il y a un risque éventuel de blessures légères.

ATTENTION !

Ce terme clé vous avertit de dommages matériels éventuels.

Autres symboles



Ce symbole désigne les conseils et indications utiles.



Ne pas couvrir!

2. Remarques importantes pour votre sécurité

La cabine infrarouge est conçue selon des règles techniques de sécurité reconnues. Cependant, des dangers peuvent survenir lors de l'utilisation. C'est pourquoi vous devez suivre les consignes de sécurité suivantes et les avertissements spécifiques des différents chapitres.

2.1. Usage conforme

La cabine infrarouge sert à réchauffer le corps humain.

L'emplacement de la cabine doit être protégé des éclaboussures. Pour un fonctionnement optimal, la température ambiante doit être d'au moins 20 °C. L'humidité ambiante maximale ne doit pas dépasser 95 %.

La cabine doit être installée sur une surface plane. Une distance d'au moins 5 cm avec le mur doit être respecté.

FR

Toute autre utilisation est considérée comme un usage non conforme. Un usage non conforme peut endommager le produit et provoquer de graves blessures, voire la mort.

2.2. Consignes de sécurité

- Les travaux de montage et de raccordement sur les parties électriques (commande, radiateurs...) doivent être effectués uniquement lorsque l'appareil n'est pas sous tension.
- Respectez également les dispositions légales du lieu d'installation.
- En cas de problèmes insuffisamment traités dans les instructions de montage, adressez-vous à votre fournisseur pour votre propre sécurité.

- La cabine ne doit pas être utilisée par des enfants de moins de 8 ans.
- La cabine peut être utilisée par des enfants de plus de 8 ans, par des personnes ayant des capacités psychiques, sensorielles ou mentales limitées et par des personnes manquant d'expérience et de connaissances que
 - sous surveillance.
 - lorsque l'utilisation en toute sécurité leur a été montrée et qu'ils comprennent les dangers qui peuvent survenir.
- Les enfants ne doivent pas jouer avec la cabine.
- Les enfants de moins de 14 ans ne peuvent nettoyer la cabine que sous surveillance.
- La cabine ne doit pas être nettoyée avec des nettoyeurs à vapeur, des nettoyeurs haute pression ou de l'eau pulvérisée.
- Pour des raisons de santé, n'utilisez pas la cabine lorsque vous êtes sous l'influence de l'alcool, de médicaments ou de drogues.
- Assurez-vous qu'aucun objet inflammable ne se trouve sur les éléments chauffants avant de mettre en marche la commande.

3. Description du produit

3.1. Étendue de la livraison MiniMy

- 1x 1-045-570 / Cabine infrarouge MiniMy
- 1x 1-037-357 / Module de puissance wave.com4 Infra
- 1x 1-012-222 / Module de commande wave.com4 Infra
- 1x 1-009-265 / Ligne de raccordement secteur infrarouge 2,5 m
- 1x 1-027-788 / Radiateur infrarouge ECO 500 - Radiateur avant foncé (pré-monté)
- 1x 1-027-785 / Radiateur infrarouge ECO 350 - Radiateur arrière foncé
- 1x 1-028-348 / Plaque chauffante IR 380 mm x 700 mm, 230 V/100 W (pré-montée)
- 1x 1-037-397 / Kit de commutateurs Plaque chauffante IR (pré-montée)
- 1x 1-028-660 / Ventilation ronde tremble 631-A
- 1x 1-028-629 / Coupelle en pierre ollaire
- 1x 1-052-935/ LED-Set WC4-Infra

FR

3.2. Fonctions du produit

Cabine infrarouge

Cabine solide en bois d'épicéa pour l'exposition aux rayons infrarouges d'1 personne.



Les poches de résine ne constituent pas un motif de réclamation. en raison de leur présence régulière dans le bois d'épicéa et de l'impossibilité de déterminer leur profondeur lors de la sélection du bois.

Si elles se trouvent juste sous la surface, elles éclatent et s'écoulent quand elle sont exposées à la chaleur.

Retirez la résine écoulee à l'aide "un chiffon imbibé d'acétone. Si vous constatez uniquement des gouttes de résine, attendez qu'elles aient durci, puis grattez-les avec précaution à l'aide d'un couteau.

Commande infrarouge wave.com4 Infra

Commande pour la gradation de 2 circuits de chauffage, chacun avec un maximum de 1,5 kW, et pour la gradation de l'éclairage et d'un ventilateur en option.



Cette commande prend en charge uniquement le mode « Régulation d'intensité ».

4. Montage de la cabine infrarouge MiniMy

Avant de commencer les travaux, vérifiez au moyen de la nomenclature si toutes les pièces ont bien été livrées. S'il devait s'avérer que des pièces manquent, informez votre revendeur dans les 14 jours suivant la réception de la cabine.



Une deuxième personne doit être disponible pour vous aider.
En outre, nous recommandons de prépercer les trous pour les vis.

4.1. Outils requis

- Marteau et cales ou maillet en caoutchouc
- Visseuse électrique avec bits pour vis en croix et Torx
- Ruban de mesure
- Niveau à bulle
- Poinçon ou bloc de bois 12 mm
- Six pans 1,5 mm

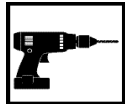

Préalésage



Contrôle de l'angle droit :

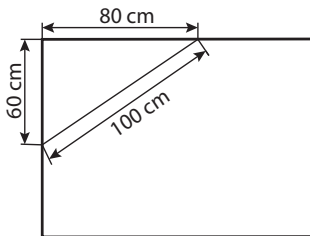

Manipulez le verre avec soin : Faire particulièrement attention avec les bords de la vitre ; en cas de choc, le verre trempé peut se briser en petits morceaux. Placez un rembourrage de protection (par ex., un emballage en carton) sous le bord de la vitre.

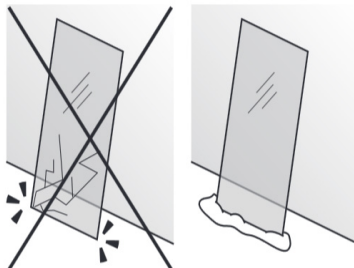

4.2. Liste des pièces cabine infrarouge MiniMy

Az	Désignation	Dimensions
Cadre de plancher		
1	Cadre de plancher arrière	103 x 9 x 4 cm
1	Cadre de plancher à droite	114 x 9 x 4 cm
1	Cadre de plancher à gauche	42 x 9 x 4 cm
Éléments muraux		
2	Élément mural A/A avec multclip	193 x 54 x 4 cm
1	Élément mural A/A avec multclip	193 x 36 x 4 cm
1	Élément mural A/B avec découpe de radiateur	193 x 45,5 x 4 cm
1	Élément mural A/B avec découpe pour projecteur et panneau de commande	193 x 45,5 x 4 cm
1	Élément en verre avec multclip	202 x 103 x 4 cm
1	Cadre de porte	202 x 72 x 4 cm
Éléments du toit		
1	Élément de toit A/B avec découpe ventilateur	107 x 45 x 4 cm
1	Élément de toit A/B	107 x 45 x 4 cm
Montant d'angle		
2	Montant d'angle à 90°	193 x 6 x 6 cm
Baguettes d'appui		
1	Baguette d'appui de toiture	112 x 4 x 4 cm
1	Baguette d'appui de toiture avec perçage	112 x 4 x 4 cm
1	Baguette d'appui de toiture	95 x 4 x 4 cm
1	Baguette d'appui de toiture avec perçage	95 x 4 x 4 cm
1	Latte du banc gauche	41 x 56 x 4 cm
1	Latte du banc droite	41 x 56 x 4 cm

Az	Désignation	Dimensions
Équipement intérieur		
1	Boîtier radiateur pin	105 x 23 x 12 cm
1	Plaque chauffante IR avec grille	79,8 x 42 x 4,5 cm
1	Banc	94,5 x 56 x 10 cm
2	Dossier Ergo	70 x 18 x 10,5 cm
1	Appui-tête VitaMy	35 x 27,5 x 8 cm
1	Cadre pour radiateur 350 W tilleul	73,5 x 23 x 2 cm
1	Baguette de recouvrement LED	95 x 3 x 3 cm
1	Plancher pin	94,4 x 61,8 x 4 cm
Élément en verre		
1	Porte en verre	191,5 x 59 x 0,8 cm
Accessoires		
1	Kit poignée bois/bois	
1	Aimant de porte, tôle extérieure	
1	2 charnières 8653-02	
2	Barre de montage pour appui-tête	13,5 x 2 x 2 cm
1	Gabarit pour montage multclip dossier	
1	Gabarit pour montage multclip partie vitrée	
2	Barre d'écartement paroi arrière	202 x 5 x 4 cm
1	Matériel de montage	
1	Instructions de montage	

4.3. Montage de la cabine

La cabine peut être montée « Porte à gauche » ou « Porte à droite ». Référez-vous aux plans Page 34 et Page 35.

Montage du cadre de plancher

Fig. 1 : Pose des trois éléments de cadre de plancher

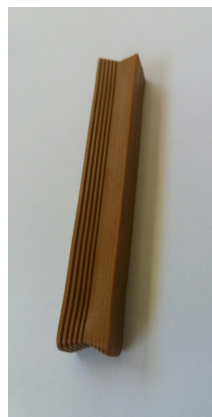
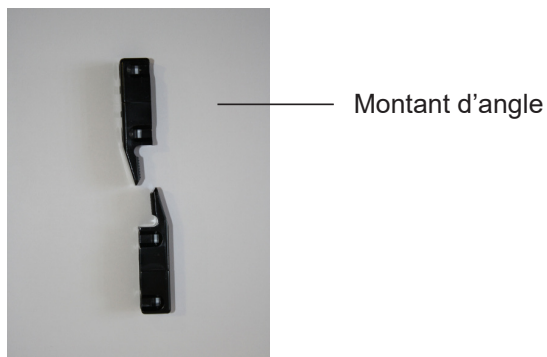

Fig. 2 : Raccorder le cadre de plancher

Tapez doucement sur les barrettes en plastique avec un marteau aux deux coins du cadre de plancher jusqu'à ce qu'elles affleurent la rainure de l'élément. Utilisez un poinçon ou un bloc de bois pour que la barrette en plastique puisse bien s'enfoncer.

**Montage des éléments muraux**

Fixez les montants d'angle aux éléments muraux au moyen des « multiclips ». Les autres éléments muraux sont reliés par des rainures et des languettes, et sont vissés les uns aux autres.

Fig. 3 : Multiclips

Attention !

Le montage du plan « Porte à gauche » est décrit ci-après.

Pour les modifications concernant le montage du plan « Porte à droite », voir Page 35.



A désigne toujours le côté apparent qui est indiqué sur la face supérieure des éléments muraux.

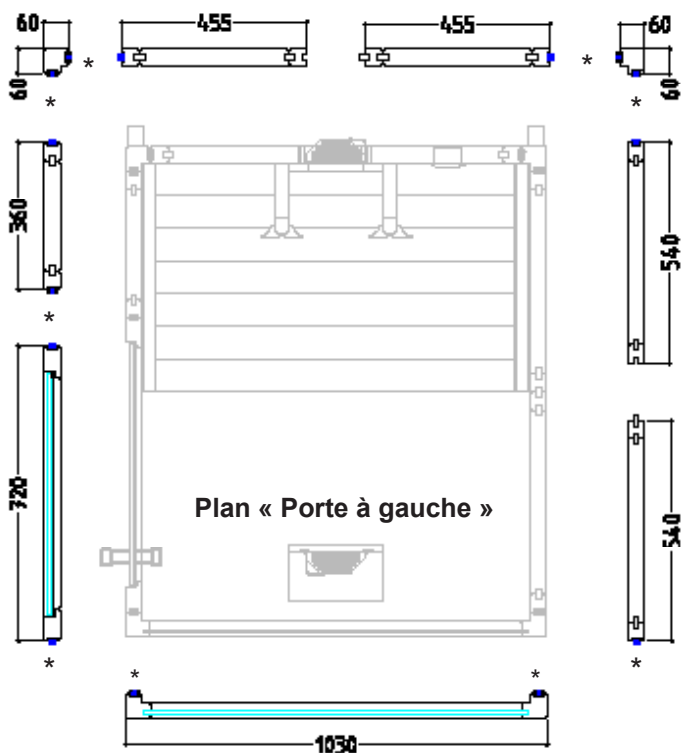

* Multiclips

Fig. 4 : Raccorder les éléments muraux avec les montants d'angle

Placez le montant d'angle du haut vers le bas sur les éléments muraux. Assurez-vous que l'orientation des « multiclips » est correcte (voir Fig. 44). Le montant d'angle doit être à fleur avec les éléments muraux.

FR

Fig. 5 : Montage sur cadre de plancher

Fig. 6 : Insérer l'élément mural avec la découpe

Après avoir inséré l'élément de radiateur, continuez avec le deuxième coin.

FR

Fig. 7 : Éléments muraux montés

Fig. 8 : Vissage des éléments muraux

Contrôlez les angles droits avant de visser les éléments muraux.
Tenez compte du conseil à la Page 8.



Foret de 3 mm, 2 vis 4 x 70 mm

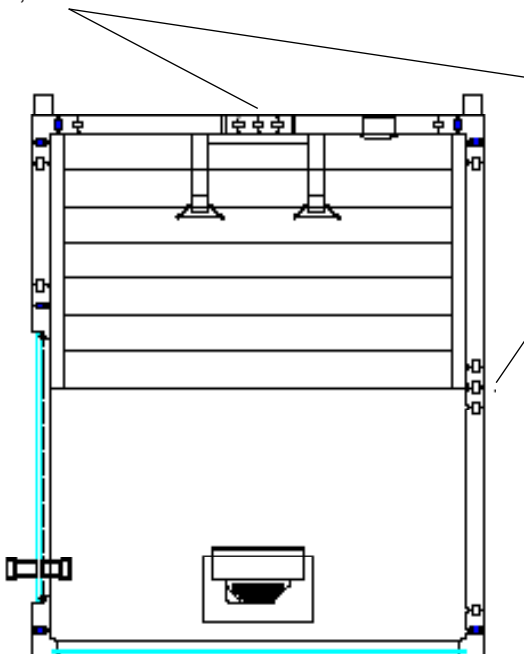

Fig. 9 : Montage de l'élément en verre



FR

Fig. 10 : Montage du cadre de porte



Montage des éléments de toit



Contrôlez les angles droits avant de visser les éléments muraux.
Tenez compte du conseil à la Page 8.

Fig. 11 : Montage baguettes d'appui de toit

Vissez les baguettes d'appui de toit comme indiqué dans Fig. 11 sur tous les murs de la cabine. Veillez à ce que les éléments muraux et la baguette d'appui de toit se rejoignent bien en position.



16 vis : 3,5 x 50 mm

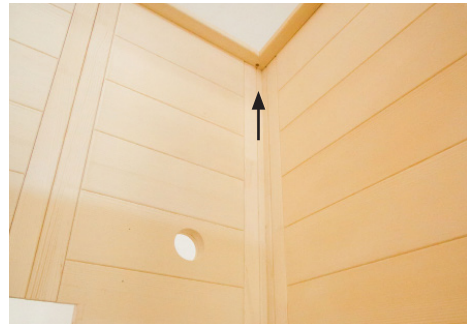

Position barre avec alésage

Fig. 12 : Baguettes d'appui de toit

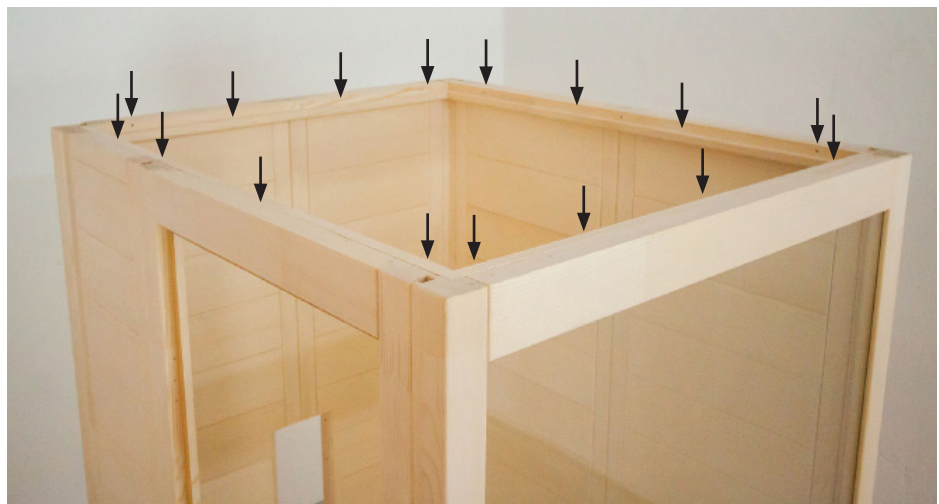

Fig. 13 : Insertion de l'élément de toit arrière avec la découpe du ventilateur

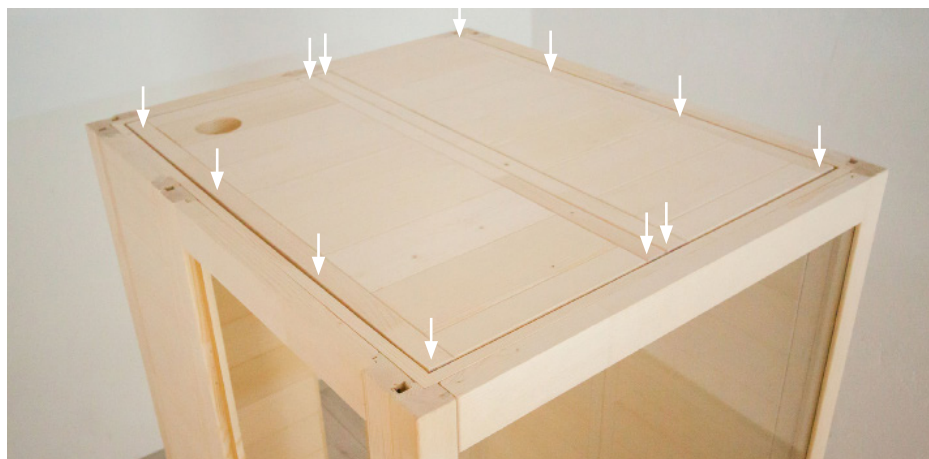

Fig. 14 : Insertion de l'élément de toit avant



FR

Fig. 15 : Fixation des éléments de toit



12 vis : 3,5 x 35 mm

Fig. 16 : Montage barre d'écartement paroi arrière

Vissez les barres d'écartement sur la paroi arrière, soit par montage affleurant, soit décalé jusqu'à 10 cm vers l'intérieur.



4 vis : 4 x 70

Montage de la ventilation**Fig. 17 : Montage de la ventilation**

Vissez l'élément de base de la ventilation avec les 3 vis fournies. Vissez ensuite la plaque en bois et fixez la vis de l'extérieur avec le capuchon en plastique.

4.4. Montage de l'équipement intérieur

Fig. 18 : Monter les supports du banc



FR

4 vis : 4 x 70 mm

4 vis : 4 x 70 mm

Fig. 19 : Poser le plancher

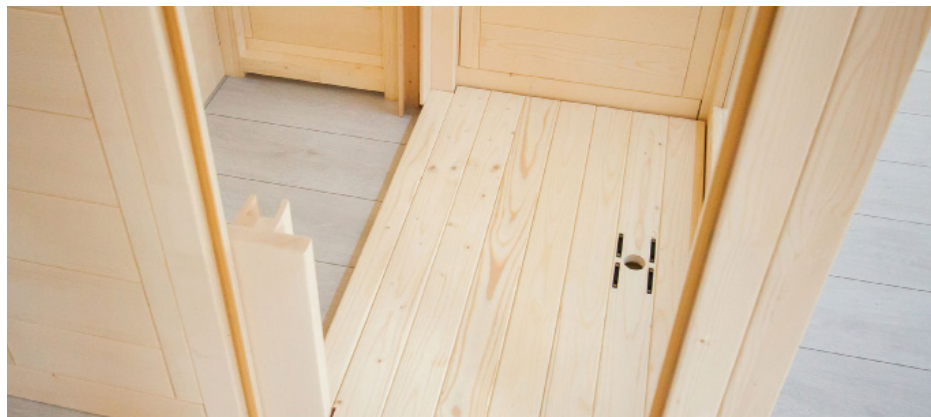

4.5. Montage des radiateurs infrarouge et de la plaque chauffante

Fig. 20 : Fixer le radiateur avant



Assurez-vous que les câbles des radiateurs avant sont librement posés au sol et ne sont pas pincés ou endommagés par le plancher de la cabine.



FR

Une fois que le radiateur est enclenché dans le plancher, fixez-le par une rotation de 90° par rapport aux vis Allen dans le sens des aiguilles d'une montre sur les quatre points de fixation.

Fig. 22 : Insertion de la coupelle en pierre ollaire**Fig. 21 : Monter le radiateur arrière (radiateur infrarouge ECO 350)****PRUDENCE !**

Veillez à ce que le boîtier de raccordement du radiateur soit sur la partie supérieure !



FR

4 vis : 3 x 18 mm

Placez le radiateur par l'arrière dans la découpe. Vissez le radiateur avec 4 vis.

Fig. 23 : Insertion de la plaque chauffante IR

Lors de l'insertion de la plaque chauffante IR, faites attention aux câbles des interrupteurs. Ceux-ci ne doivent pas être pincés ou endommagés.



FR

Placez la plaque chauffante IR dans les barres en U. Le renforcement sert à faire passer le câble du radiateur avant.

4.6. Montage de la barre à LED**Fig. 24 : Fixer la barre à LED**

3 vis : 3,5 x 50 mm

Vissez la baguette de recouvrement LED par en haut (préperçage)

4.7. Montage de la commande infrarouge

 Pour le montage, la mise en service et l'exploitation, observez les instructions fournies avec la commande. Cette commande prend en charge uniquement le mode « Régulation d'intensité ».

Raccordement du bloc de puissance

Le bloc de puissance de la commande est placé sous le banc de la cabine. Faites passer la fiche secteur à travers l'ouverture du panneau arrière et raccordez les câbles comme suit.

Groupe chauffant 1 : radiateur arrière, plaque chauffante IR (avec interrupteur)

Groupe chauffant 2 : radiateur avant

Fig. 25 : Exemple de raccordement

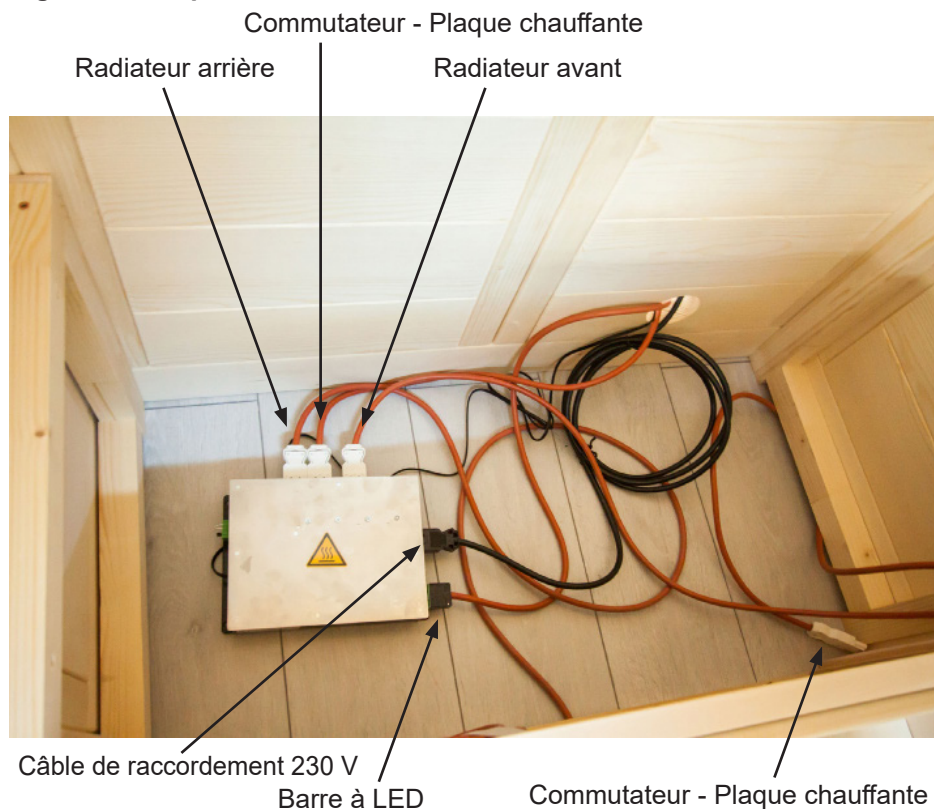
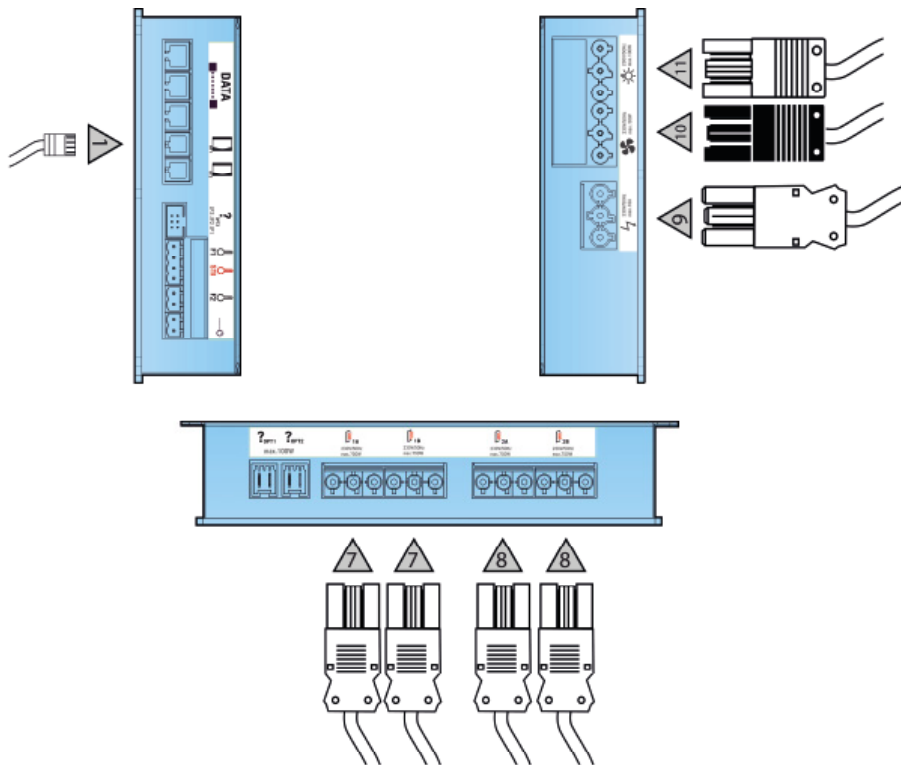

Fig. 26 : Raccordements du bloc de puissance



FR

Connecteur	Description
1	Élément de commande wave.com4 infra
7	Groupe chauffant IR 1
8	Groupe chauffant IR 2
9	Raccordement au secteur
10	Raccordement du ventilateur (noir) - facultatif
11	Raccordement lumière (vert)

Raccordement de la LED RGBW

Fig. 27 : Raccordement de la RGBW LED à la commande



Placez le gradateur pour l'éclairage LED sous le banc. Faites passer le câble de connexion et la fiche d'alimentation à travers l'ouverture du panneau arrière.

4.8. Montage du banc

Une fois la commande entièrement connectée, le banc peut être assemblé.

Fig. 28 : Fixation du banc



2 vis : 4 x 70 mm

Placez le banc sur les barres de support. Poussez les sièges vers l'avant.



PRUDENCE !

Fixez le banc avec les vis de fixation en biais contre la paroi arrière afin d'éviter qu'il ne glisse.

4.9. Montage des dossiers et des appui-têtes

Le montage du cadre pour le projecteur se fait par l'arrière (pré-perçage) avec 4 vis de 3,5 x 50 mm. Si ce n'est pas possible, fixez-le avec les vis par l'avant (voir photo de droite).

Vissez fermement les multiclips avec les 8 vis de 3,5 x 35 mm fournies en utilisant le gabarit de montage.

Fig. 29 : Montage des dossiers



Insérez ensuite les dossiers de haut en bas sur les supports jusqu'à ce qu'ils s'enclenchent.

Fig. 30 : Montage des appui-têtes

4 vis : 3,5 x 35 mm



Vissez les supports latéralement afin qu'ils affleurent les dossiers. La hauteur peut varier au choix. Ensuite, insérez l'appui-tête dans la position désirée.

FR



4.10. Montage des portes

Fig. 31 : Montage des ferrures de portes 1



FR

Vissez les deux ferrures de porte à la porte en verre, en vous assurant que les ferrures sont au niveau de la porte et que la porte s'ouvre vers l'extérieur.



L'orientation des ferrures est effectuée en ajustant/tournant les deux bagues en plastique.

Fig. 32 : Montage des ferrures de portes 2



Fig. 33 : Montage de la poignée de porte

Insérez d'abord les deux inserts en silicone dans les trous de la poignée de porte sur l'élément en verre. Ensuite, vissez soigneusement les deux poignées ensemble.

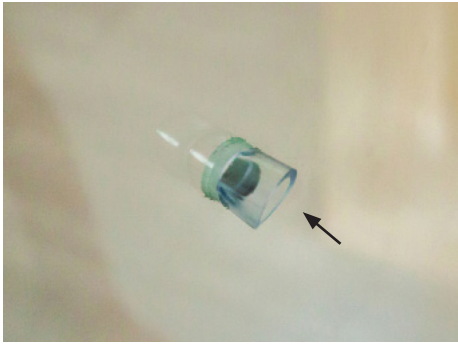

2 vis : 5 x 100 mm



FR

L'alésage inférieur de la poignée de porte se trouve à une hauteur de 92,5 cm. Les poignées sont vissées ensemble depuis l'intérieur.

Fig. 34 : Montage de l'aimant de la porte

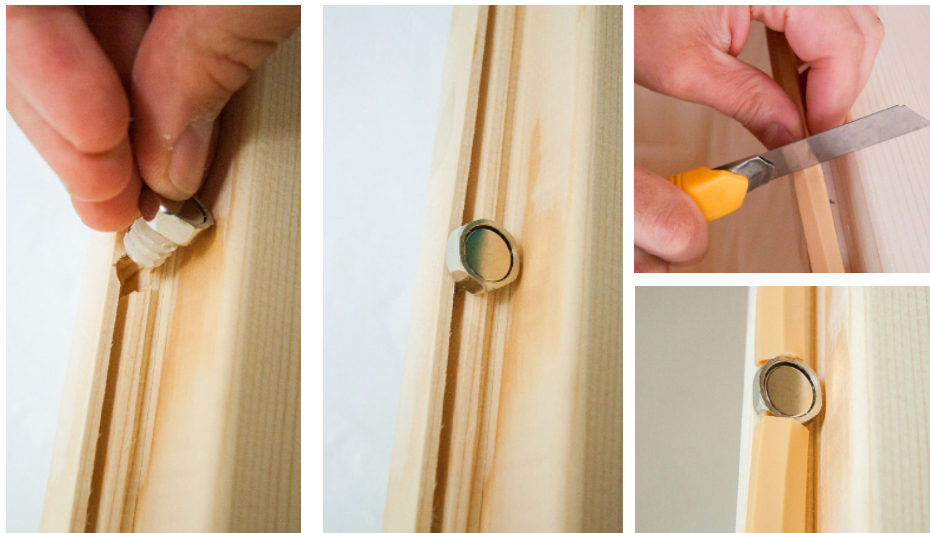

Fig. 35 : Montage de la tôle extérieure



5. Nettoyage et entretien

5.1. Nettoyage

ATTENTION !

Dommages sur la cabine

- Ne versez pas d'eau sur la cabine et les composants électroniques.
- Ne nettoyez pas la cabine et les composants électroniques en utilisant trop d'humidité.

5.2. Entretien

La cabine infrarouge MiniMy ne nécessite pas d'entretien.

6. Dépannage

- En cas de problèmes insuffisamment traités dans les instructions de montage, adressez-vous à votre fournisseur pour votre propre sécurité.

7. Élimination

FR



- Éliminez les matériaux d'emballage conformément aux directives en vigueur relatives à l'élimination.
- Les appareils usagés contiennent des matériaux recyclables, mais aussi des substances toxiques. Par conséquent, ne jetez en aucun cas votre appareil usagé avec les déchets ménagers. Éliminez-le conformément aux directives locales en vigueur.

8. Caractéristiques techniques

Conditions ambiantes

Température de stockage :	-25 °C à +70 °C
Température ambiante :	20 °C à +30 °C
Humidité de l'air :	max. 95 %

9. Plan

Comme le bois est un produit naturel, des écarts mineurs sont possibles.

9.1. Plan « Porte à gauche »

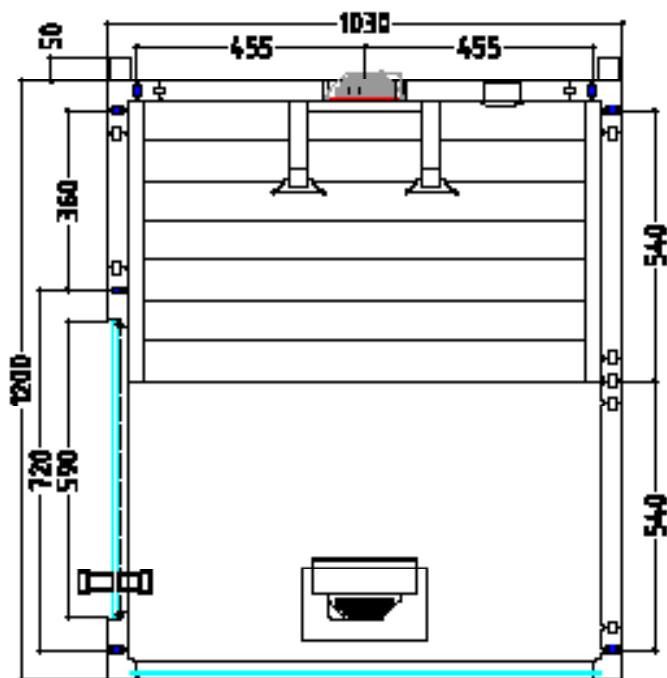

9.2. Plan « Porte à droite »

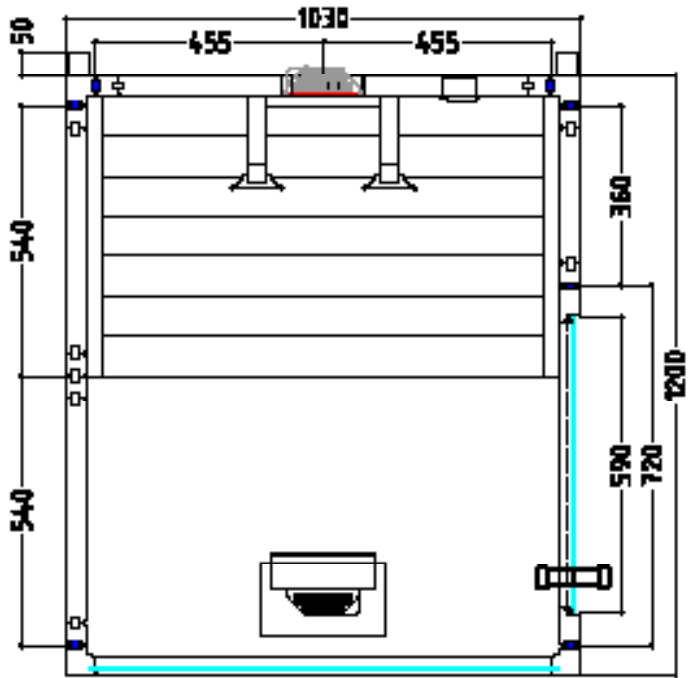

9.3. Modifications lors du montage selon le plan « Porte à droite »

Pour le montage de l'élément en verre (Page 16)

Retirez les multiclips de l'élément en verre et montez-les dans la position marquée en utilisant les gabarits inclus.

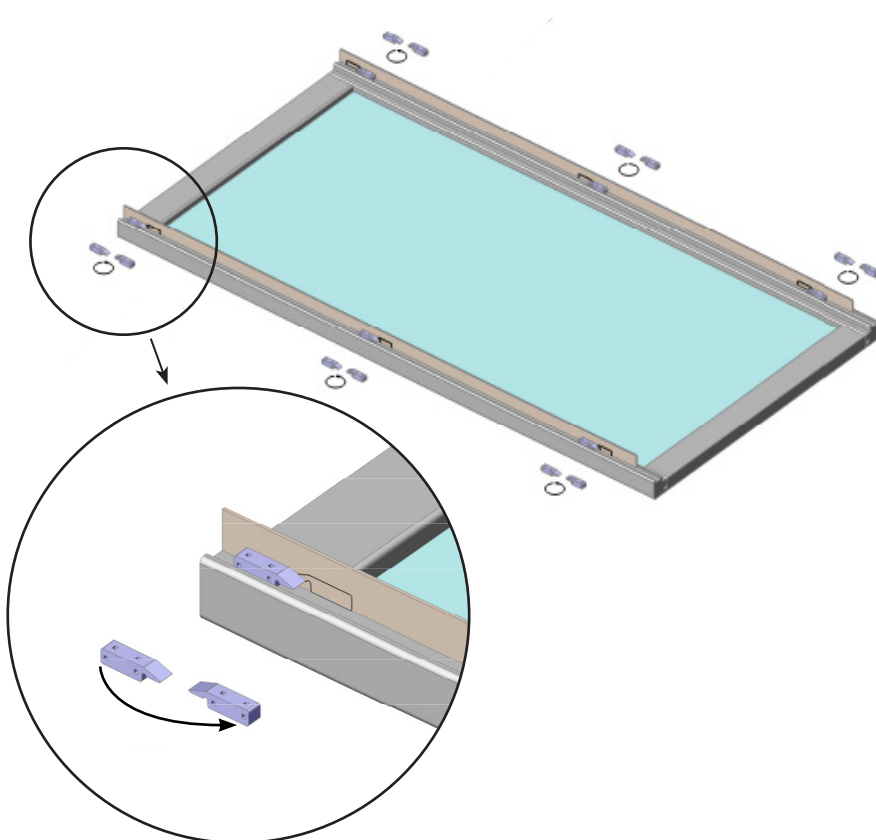

Harvia MiniMy 120 Basic

HARVIA

Cabina a infrarossi

Istruzioni di montaggio e per l'uso

120 x 130 x 202 cm

N. articolo

MINIMY-120-B



IT



**CE UK
CA**

Indice

1. Informazioni sul presente manuale	3
2. Importanti indicazioni per la sicurezza personale	4
2.1. Conformità d'uso	4
2.2. Indicazioni di sicurezza	4
3. Descrizione del prodotto	6
3.1. Volume di fornitura MiniMy	6
3.2. Funzioni del prodotto	6
4. Montaggio della cabina a infrarossi MiniMy	7
4.1. Attrezzi necessari	7
4.2. Elenco dei pezzi della cabina a infrarossi MiniMy	8
4.3. Montaggio della cabina	10
4.4. Montaggio dell'allestimento interno	20
4.5. Montaggio dell'irradiatore a infrarossi e del pannello radiante	21
4.6. Montaggio del listello a LED	23
4.7. Installazione del comando a infrarossi	24
4.8. Montaggio della panca	27
4.9. Montaggio degli schienali e dei poggiatesta	28
4.10. Montaggio della porta	30
5. Pulizia e manutenzione	33
5.1. Pulizia	33
5.2. Manutenzione	33
6. Risoluzione dei problemi	33
7. Smaltimento	33
8. Specifiche tecniche	34
9. Pianta	34
9.1. Pianta "Porta a sinistra"	34
9.2. Pianta "Porta a destra"	35
9.3. Differenze di montaggio pianta "Porta a destra"	36

1. Informazioni sul presente manuale

Leggere attentamente le presenti istruzioni di montaggio e d'uso e conservarle vicino alla cabina a infrarossi. Così facendo è possibile controllare in ogni momento le informazioni sulla sicurezza e sull'utilizzo.



Le presenti istruzioni di montaggio e d'uso si trovano anche nell'area di download della nostra pagina web all'indirizzo:
www.mediabank.harvia.com.

Simboli nelle avvertenze

Nelle presenti istruzioni di montaggio e d'uso, prima di ogni attività che genera un pericolo è applicata un'avvertenza. Osservare sempre queste avvertenze. Così facendo, si evitano danni a beni materiali e lesioni che, nel peggiore dei casi, possono essere addirittura mortali.

Nelle avvertenze vengono utilizzati pittogrammi che hanno i seguenti significati:



PERICOLO!

L'inosservanza di questa avvertenza può causare lesioni gravi o addirittura mortali.



AVVERTENZA!

L'inosservanza di questa avvertenza può causare lesioni gravi o addirittura mortali.



ATTENZIONE!

L'inosservanza di questa avvertenza può causare lesioni lievi.

ATTENZIONE!

Questo pittogramma avverte della possibilità di danni a beni materiali.

Altri simboli



Questo simbolo indica consigli e indicazioni utili.

2. Importanti indicazioni per la sicurezza personale

La cabina a infrarossi è costruita secondo le regole tecniche di sicurezza riconosciute. Tuttavia, durante l'utilizzo possono presentarsi pericoli. Osservare pertanto le seguenti indicazioni di sicurezza e le avvertenze speciali riportate nei singoli capitoli.

2.1. Conformità d'uso

La cabina a infrarossi è usata per riscaldare il corpo umano.

La posizione della cabina deve essere protetta dagli spruzzi d'acqua. Per un funzionamento ottimale, il luogo dovrebbe avere una temperatura ambiente di almeno 20 °C. L'umidità dell'aria ambiente massima non deve superare il 95%.

La cabina deve essere collocata su una superficie piana. Mantenere una distanza minima dalle pareti di 5 cm.

Qualsiasi altro utilizzo è considerato improprio. Un utilizzo improprio può causare danni al prodotto e lesioni gravi o mortali.

IT

2.2. Indicazioni di sicurezza

- I lavori di montaggio e di collegamento dei componenti meccanici (comando, irradiator, ...) possono essere eseguiti solo in assenza di tensione.
- Osservare anche le disposizioni locali valide sul luogo di installazione.
- Qualora si presentassero problemi non trattati in modo esaustivo nelle presenti istruzioni di montaggio, per la vostra sicurezza vi preghiamo di rivolgervi al vostro fornitore.

- La cabina non può essere utilizzata da bambini di età inferiore agli 8 anni.
- La cabina può essere utilizzata da bambini sopra gli 8 anni di età, da persone con capacità fisiche, sensoriali o mentali limitate o prive della sufficiente esperienza e del know-how necessari nei seguenti casi:
 - se sono in presenza di persone responsabili per loro;
 - se è stato spiegato loro come utilizzare l'apparecchio in modo sicuro e sono chiari i pericoli che ne possono derivare.
- Ai bambini non è permesso giocare con la cabina.
- I bambini al di sotto dei 14 anni possono pulire la cabina solo in presenza di adulti.
- La cabina non può essere pulita con vaporizzatori, idropultrici ad alta pressione o spruzzi d'acqua.
- Se si è sotto l'effetto di alcol, medicinali o droghe, per motivi di salute evitare l'uso della sauna.
- Prima di attivare il comando, accertarsi che non si trovino oggetti infiammabili sulle resistenze.

3. Descrizione del prodotto

3.1. Volume di fornitura MiniMy

- 1x 1-045-570 / Cabina a infrarossi MiniMy
- 1x 1-037-357 / Unità di potenza wave.com4 Infra per VitaMy
- 1x 1-012-222 / Unità di comando wave.com4 Infra
- 1x 1-009-265 / Cavo di collegamento alla rete a raggi infrarossi 2,5 m
- 1x 1-027-788 / Irradiatore a infrarossi ECO 500 - scuro - Irradiatore anteriore (premontato)
- 1x 1-027-785 / Irradiatore a infrarossi ECO 350 - scuro - Irradiatore posteriore
- 1x 1-028-348 / Pannello radiante IR 380mm x 700 mm, 230 V/100 W (premontato)
- 1x 1-037-397 / Set di interruttori pannello radiante IR (premontato)
- 1x 1-028-660 / Sfiato tondo Espe 631-A
- 1x 1-028-629 / Ciotola in pietra ollare
- 1x 1-052-935 / Set di LED WC4-Infra

IT

3.2. Funzioni del prodotto

Cabina a infrarossi

Cabina in legno massello di abete rosso per la radiazione a raggi infrarossi per 1 persona.



Le tasche di resina non sono motivo di reclamo perché nel legno di abete rosso sono sempre presenti e durante la selezione non è possibile rilevare a quale profondità si trovino.

Quando sono appena al di sotto della superficie, con lo sviluppo del calore si rompono e possono “essudare”.

Rimuovere la resina fuoriuscita con un panno imbevuto di acetone. Se sono presenti solo gocce di resina, lasciarle indurire e poi raschiarle con cautela usando un coltello.

Controllo dei raggi infrarossi wave.com4 Infra

Comando per la regolazione di 2 circuiti di riscaldamento con un massimo di 1,5 kW ciascuno e per la regolazione della luce e di un ventilatore opzionale.



Questo comando supporta solo la modalità di funzionamento “Regolazione dell'intensità”.

4. Montaggio della cabina a infrarossi MiniMy

Prima di iniziare i lavori, controllare in base all'elenco dei pezzi se tutti i singoli componenti sono stati effettivamente forniti. Se eccezionalmente dovessero mancare dei singoli componenti, contattare il proprio fornitore entro 14 giorni dal ricevimento della cabina.



Per il montaggio è richiesto l'aiuto di una seconda persona.
Raccomandiamo anche di preforare i fori per le viti.

4.1. Attrezzi necessari

- Martello e pezzo di legno oppure martello in gomma
- Avvitatore elettrico con punte per viti con testa a croce e viti Torx
- Metro a nastro avvolgibile
- Livella a bolla
- Punzone o blocco di legno da 12 mm
- Chiave a brugola 1,5 mm

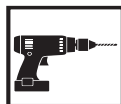

Preforatura



Verifica dell'ortogonalità:

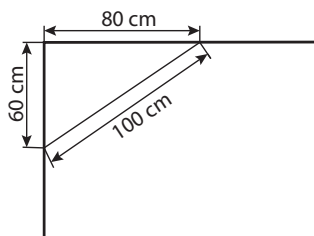

Maneggiare il vetro con cura: particolare attenzione deve essere prestata ai bordi del vetro - il vetro temprato può frantumarsi in piccoli pezzi in caso di impatto. Inserire un cuscinio di protezione (ad es: scatola di cartone) sotto il bordo del vetro.

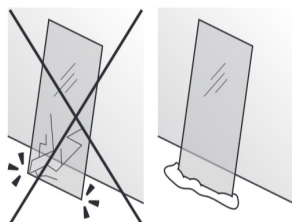

4.2. Elenco dei pezzi della cabina a infrarossi MiniMy

Pz.	Denominazione	Dimensioni
Telaio di base		
1	Telaio di base posteriore	103 x 9 x 4 cm
1	Telaio di base a destra	114 x 9 x 4 cm
1	Telaio di base a sinistra	42 x 9 x 4 cm
Elementi parete		
2	Elemento parete A/A con multclip	193 x 54 x 4 cm
1	Elemento parete A/A con multclip	193 x 36 x 4 cm
1	Elemento parete A/B con intaglio per irradiatore	193 x 45,5 x 4 cm
1	Elemento parete A/B con intaglio per irradiatore e pannello di controllo	193 x 45,5 x 4 cm
1	Elemento in vetro con multclip	202 x 103 x 4 cm
1	Telaio della porta	202 x 72 x 4 cm
Elementi del tetto		
1	Elemento del tetto A/B con apertura per il ventilatore	107 x 45 x 4 cm
1	Elemento del tetto A/B	107 x 45 x 4 cm
Montante angolare		
2	Montante angolare 90°	193 x 6 x 6 cm
Listelli di supporto		
1	Listello di supporto tetto	112 x 4 x 4 cm
1	Listello di supporto del tetto con foro	112 x 4 x 4 cm
1	Listello di supporto tetto	95 x 4 x 4 cm
1	Listello di supporto del tetto con foro	95 x 4 x 4 cm
1	Supporto panca a sinistra	41 x 56 x 4 cm
1	Supporto panca a destra	41 x 56 x 4 cm

Pz.	Denominazione	Dimensioni
Allestimento interno		
1	Alloggiamento irradiatore in abete rosso	105 x 23 x 12 cm
1	Pannello radiante IR con griglia	79,8 x 42 x 4,5 cm
1	Panca	94,5 x 56 x 10 cm
2	Schienale ergonomico	70 x 18 x 10,5 cm
1	Poggiatesta VitaMy	35 x 27,5 x 8 cm
1	Telaio per irradiatore 350 W Linde	73,5 x 23 x 2 cm
1	Listello di copertura per LED	95 x 3 x 3 cm
1	Pavimento in abete rosso	94,4 x 61,8 x 4 cm
Elemento in vetro		
1	Porta in vetro	191,5 x 59 x 0,8 cm
Accessori		
1	Set maniglia porta legno/legno	
1	Magnete per porta, lamierino di battuta	
1	2 cerniere per porta 8653-02	
2	Listello di montaggio per poggiatesta	13,5 x 2 x 2 cm
1	Dima per montaggio con multclip dello schienale	
1	Dima per montaggio con multclip dell'elemento frontale in vetro	
2	Asta respingente pannello posteriore	202 x 5 x 4 cm
1	Materiale di montaggio	
1	Istruzioni di montaggio	

4.3. Montaggio della cabina

La cabina può essere montata con la “porta a sinistra” o la “porta a destra”; consultare le piante a Pagina 34 e Pagina 35.

Montaggio del telaio di base

Fig. 1: Posizionamento di tre elementi del telaio di base

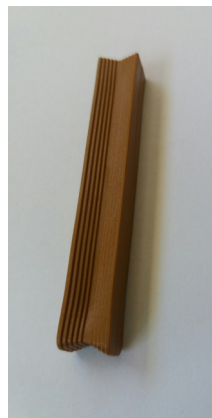

IT



Fig. 2: Collegamento del telaio di base

Battere con cautela i supporti a coda di rondine con un martello su entrambi gli angoli del telaio di base fino a quando non sono a filo con la scanalatura dell'elemento.

Usare un punzone o un blocco di legno per assicurarsi che la rondine in plastica possa essere inserita bene.

**Montaggio degli elementi parete**

I montanti angolari vengono collegati agli elementi parete mediante "multiclip". Gli altri elementi parete vengono collegati con scanalatura e linguetta e avvitati tra loro.

IT

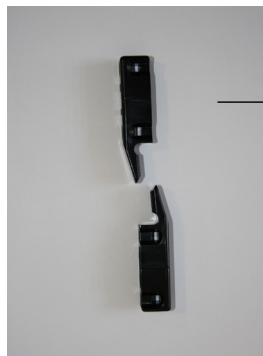
Fig. 3: Multiclip

Montante
angolare

Attenzione!

Di seguito viene descritta la sequenza di montaggio per la pianta "Porta a sinistra".
 Differenze di montaggio per la pianta "Porta a destra" - vedi Pagina 35.



A: indica sempre il lato a vista ed è riportata sulla parte superiore degli elementi parete.

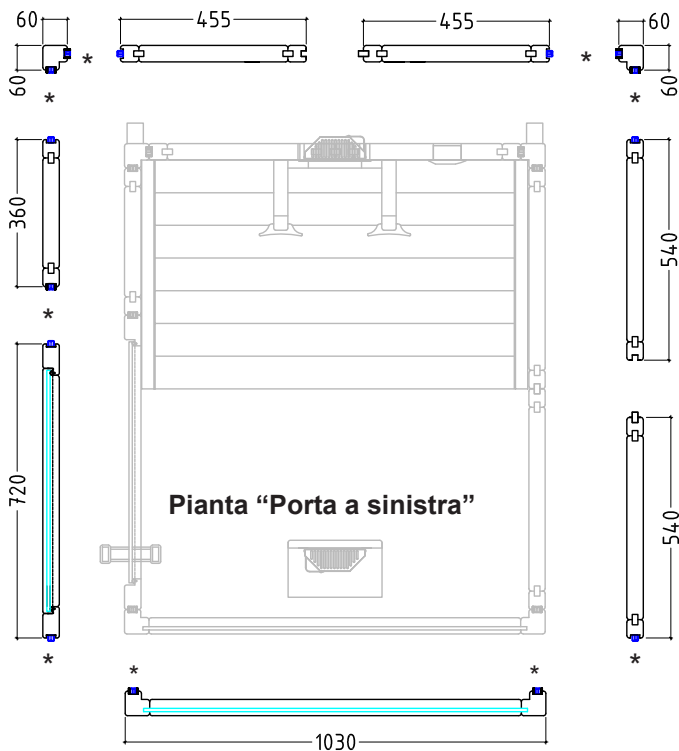

* Multiclip

Fig. 4: Collegamento degli elementi parete con il montante angolare

Innestare i montanti angolari dall'alto verso il basso sugli elementi parete. Nel farlo, prestare attenzione all'orientamento corretto delle "multiclip" (vedere Fig. 44). I montanti devono essere a filo con gli elementi parete.

IT

Fig. 5: Montaggio sul telaio di base

Fig. 6: Inserimento dell'elemento parete con intaglio

Dopo aver inserito l'elemento radiante, continuare con il secondo angolare.

IT

Fig. 7: Elementi pareti montati

Fig. 8: Collegamento a vite degli elementi parete

Verificare l'ortogonalità degli elementi parete prima di avvitarli tra loro. Seguire l'indicazione a pagina Pagina 8.



Punta per trapano da 3 mm, 2 viti 4 x 70 mm

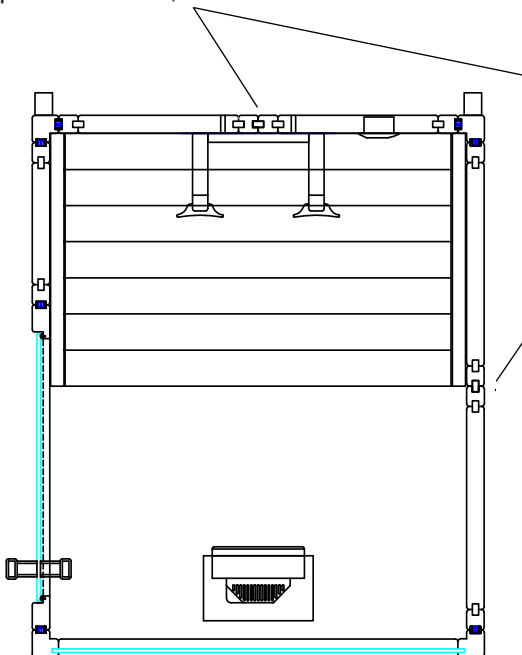

Fig. 9: Montaggio dell'elemento in vetro



IT

Fig. 10: Montaggio del telaio della porta



Montaggio degli elementi tetto



Verificare l'ortogonalità degli elementi parete prima di avvitarli tra loro. Seguire l'indicazione a Pagina 8.

Fig. 11: Montaggio dei listelli di supporto del tetto

Avvitare i listelli di supporto del tetto su tutte le pareti della cabina come mostrato in Fig. 11. Nel farlo, assicurarsi che gli elementi parete e il listello di supporto del tetto siano a filo.



16 viti: 3,5 x 50 mm

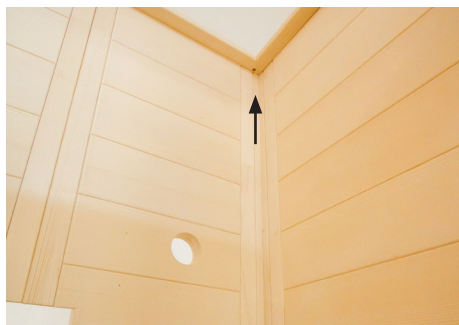

Posizione listello con foro

Fig. 12: Listelli di supporto del tetto



Fig. 13: Inserimento dell'elemento del tetto posteriore con apertura per il ventilatore

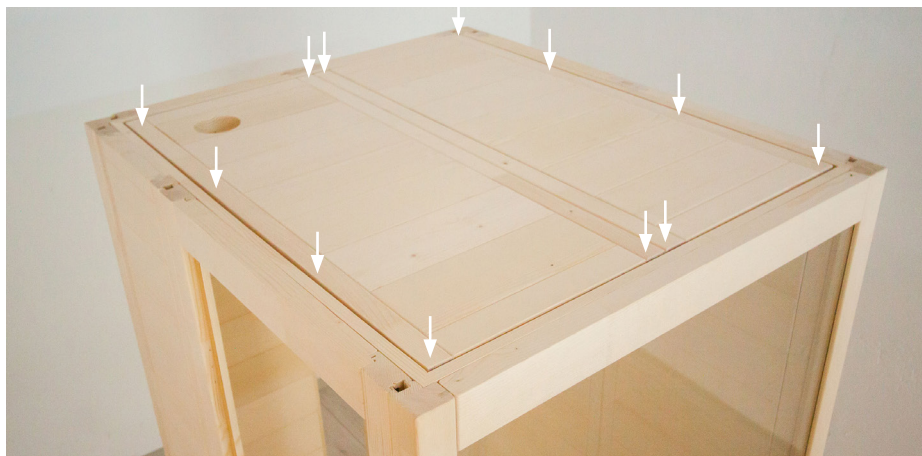

Fig. 14: Inserimento dell'elemento tetto anteriore



IT

Fig. 15: Fissaggio degli elementi tetto



12 viti: 3,5 x 35 mm

Fig. 16: Montaggio delle barre distanziatrici sul pannello posteriore

Avvitare i listelli distanziatori al pannello posteriore, a filo o sfalsati verso l'interno fino a 10 cm.

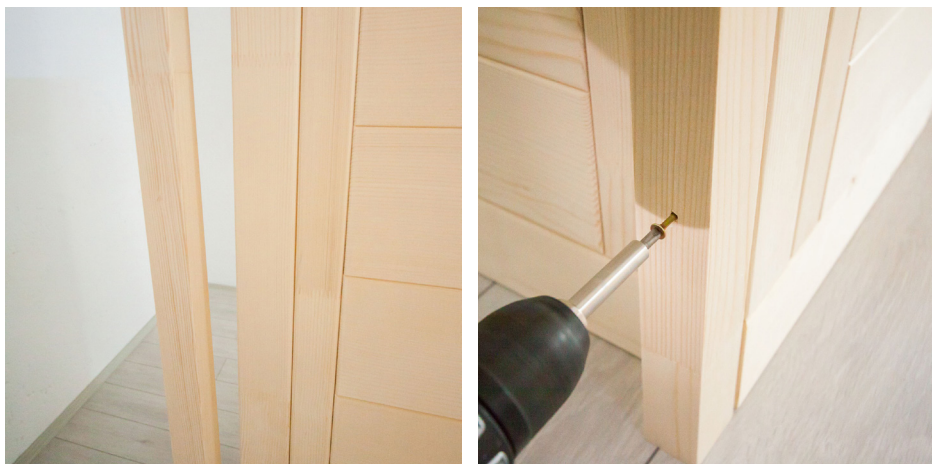

4 viti: 4 x 70

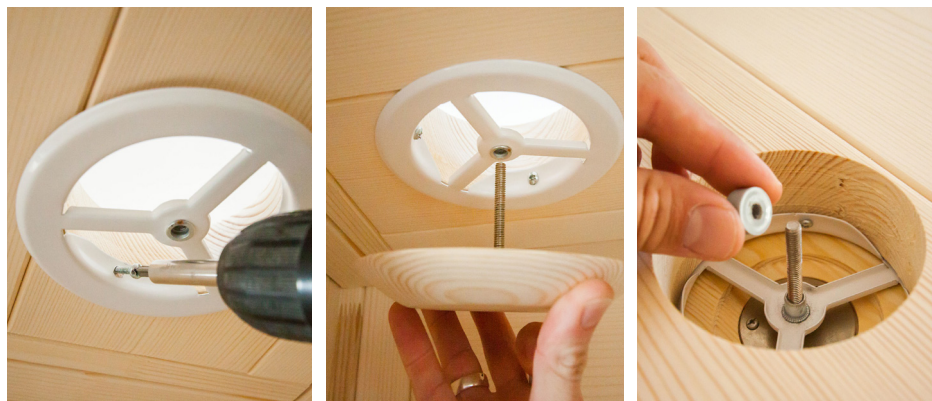
Montaggio della ventilazione**Fig. 17: Montaggio della ventilazione**

Avvitare l'elemento base della ventilazione con le 3 viti in dotazione. Poi avvitare il coperchio in legno e fissare la vite dall'esterno con il tappo di plastica.

4.4. Montaggio dell'allestimento interno

Fig. 18: Montare i supporti della panca



4 viti: 4 x 70 mm

4 viti: 4 x 70 mm

Fig. 19: Inserimento del pavimento

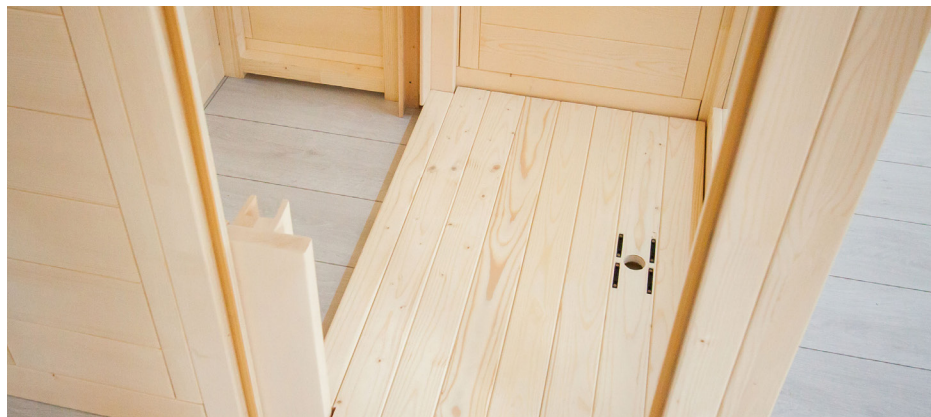

4.5. Montaggio dell'irradiatore a infrarossi e del pannello radiante

Fig. 20: Fissaggio degli irradiatori anteriori



Assicurarsi che i cavi degli irradiatori anteriori poggino liberi sul pavimento e non siano schiacciati o danneggiati dal pavimento della cabina.



IT

Dopo avere inserito l'irradiatore sul pavimento, fissarlo ai quattro punti di fissaggio ruotando in senso orario le viti a brugola di 90°.

Fig. 22: Inserimento della ciotola in pietra ollare**Fig. 21: Montaggio degli irradiatori posteriori (irradiatore a infrarossi ECO 350)****ATTENZIONE!**

Assicurarsi che la morsetteria degli irradiatori sia montata sul lato superiore!

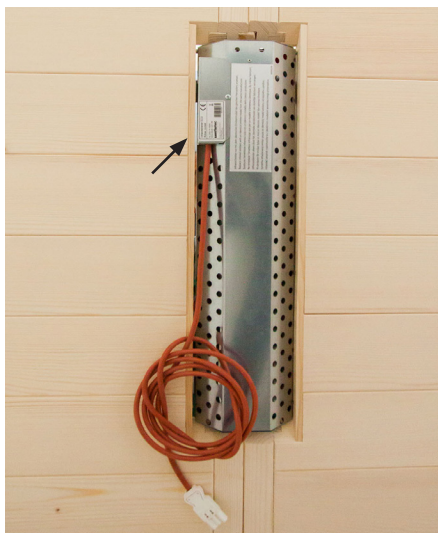

4 viti: 3 x 18 mm

Inserire l'irradiatore nell'apertura dall'interno. Fissare l'irradiatore con le 4 viti.

Fig. 23: Inserimento del pannello radiante IR

Quando si inserisce il pannello radiante IR, fare attenzione ai cavi degli interruttori che non devono essere schiacciati o danneggiati.



Inserire il pannello radiante IR nei listelli a U. La rientranza serve a far passare il cavo dell'irradiatore anteriore.

IT

4.6. Montaggio del listello a LED**Fig. 24: Fissaggio del listello a LED**

3 viti: 3,5 x 50 mm

Avvitare il listello di copertura dei LED dall'alto (preforato)

4.7. Installazione del comando a infrarossi



Per il montaggio, la messa in funzione e il funzionamento, seguire le istruzioni allegate all'unità di comando. Questa supporta solo la modalità di funzionamento "regolazione dell'intensità".

Collegamento dell'unità di potenza

L'unità di potenza del comando è posizionata sotto la panca della cabina. Far passare la spina di rete attraverso l'apertura nel pannello posteriore verso l'esterno e collegare i cavi come segue.

Gruppo di riscaldamento 1: Irradiatore posteriore, pannello radiante IR (tramite interruttore)

Gruppo di riscaldamento 2: Radiatore anteriore

Fig. 25: Esempio di allacciamento

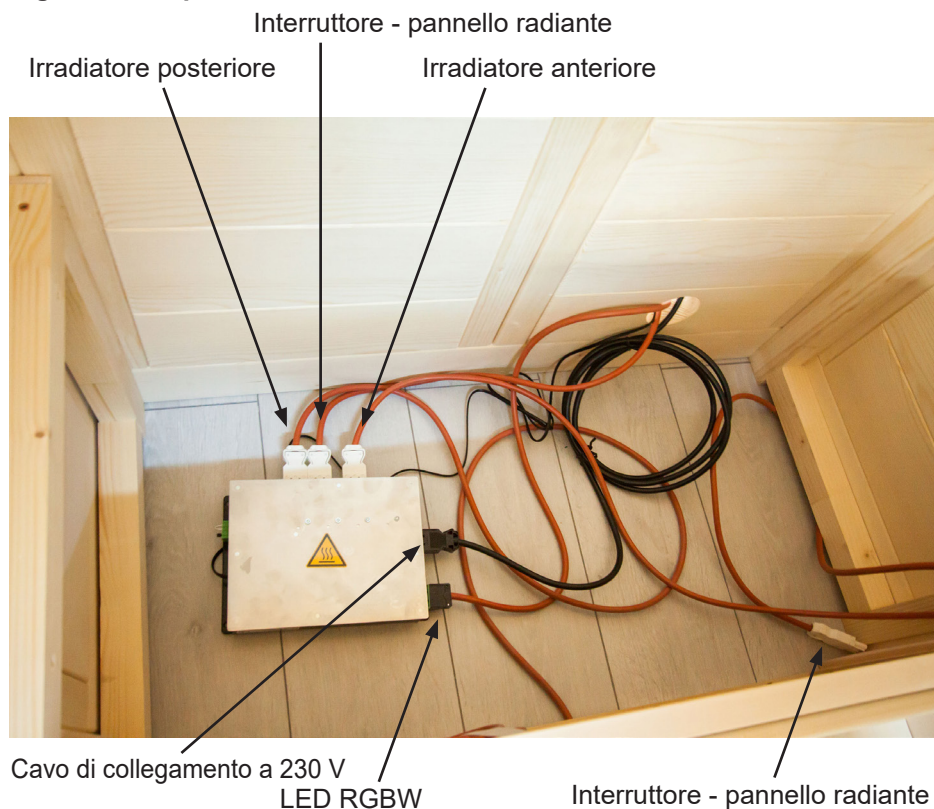
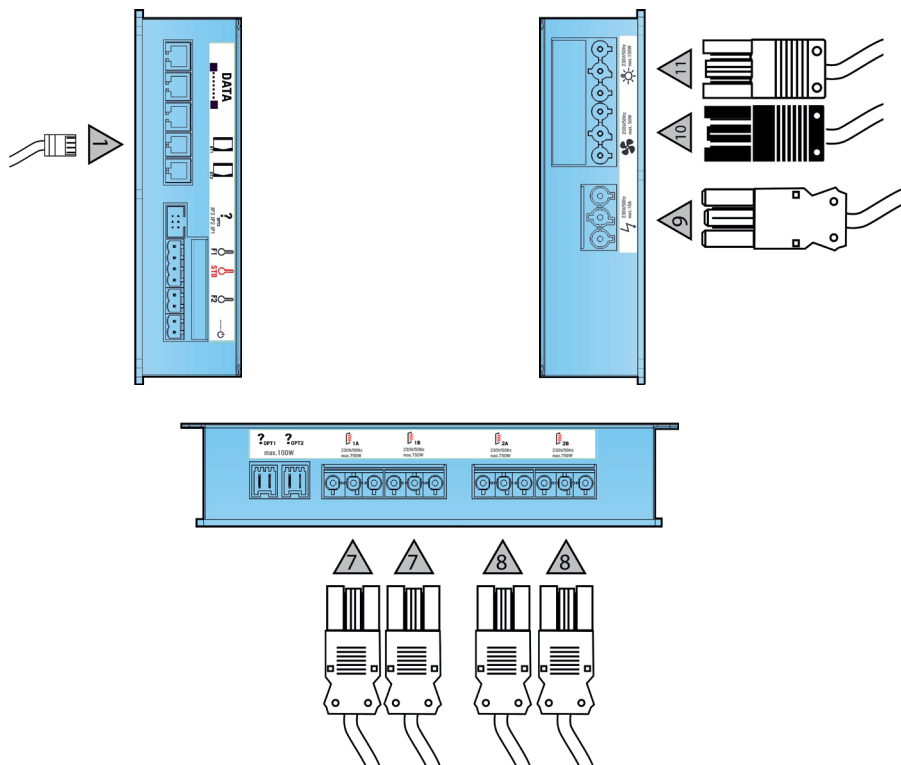
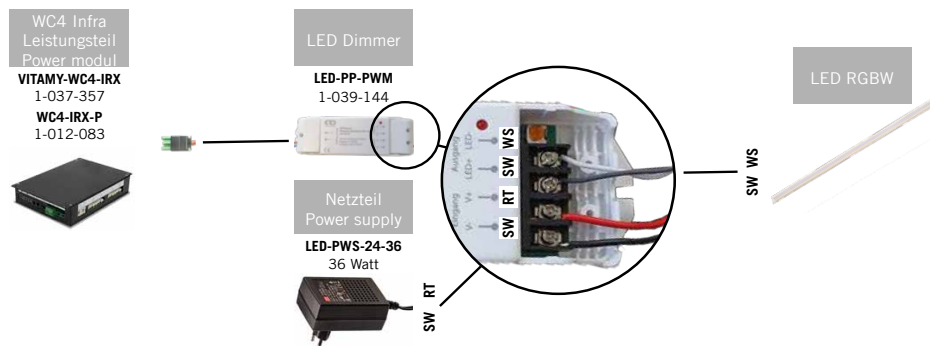

Fig. 26: Collegamenti dell'unità di potenza

Connettore	Descrizione
1	Unità di comando wave.com4 Infra
7	Gruppo riscaldamento IR 1
8	Gruppo riscaldamento IR 2
9	Collegamento alla rete
10	Collegamento del ventilatore (nero) - opzionale
11	Collegamento luce (verde)

Collegamento del LED RGBW

Fig. 27: Collegamento del LED RGBW al comando



Posizionare il dimmer del LED sotto la panca. Fare passare il cavo di collegamento e la spina di rete attraverso l'apertura nel pannello posteriore.

4.8. Montaggio della panca

Dopo aver collegato il comando, la panca può essere montata.

Fig. 28: Fissaggio della panca



2 viti: 4 x 70 mm

Posizionare la panca sui listelli di supporto. Spingere il piano di seduta in avanti.



ATTENZIONE!

Per evitare che la panca scivoli, fissarla con le viti di bloccaggio in diagonale contro la parete.

4.9. Montaggio degli schienali e dei poggiatesta

Il telaio dell'irradiatore viene montato dal lato posteriore (preforato) con 4 viti 3,5 x 50 mm. Se questo non fosse possibile, fissarlo con le viti da davanti (vedi foto a destra).

Avvitare le multiclip con l'aiuto della dima di montaggio usando le 8 viti 3,5 x 35 mm in dotazione.

Fig. 29: Montaggio degli schienali



Infine, spingere gli schienali sui supporti dall'alto verso il basso finché non scattano in posizione.

Fig. 30: Montaggio dei poggiatesta

4 viti: 3,5 x 35 mm



Fissare i supporti allineandoli ai lati degli schienali. L'altezza può essere variata a seconda delle esigenze. Quindi posizionare il poggiatesta nella posizione desiderata.



4.10. Montaggio della porta

Fig. 31: Montaggio delle cerniere della porta 1



Fissare entrambe le cerniere della porta alla porta in vetro, assicurandosi che le cerniere siano allineate longitudinalmente e che la porta si apra verso l'esterno.

IT



L'orientamento delle cerniere viene eseguito regolando/ruotando i due anelli in plastica.

Fig. 32: Montaggio delle cerniere della porta 2



Fig. 33: Montaggio della maniglia della porta

Per prima cosa inserire i due inserti in silicone nei fori per la maniglia della porta sull'elemento in vetro. Poi avvitare attentamente le due maniglie insieme.

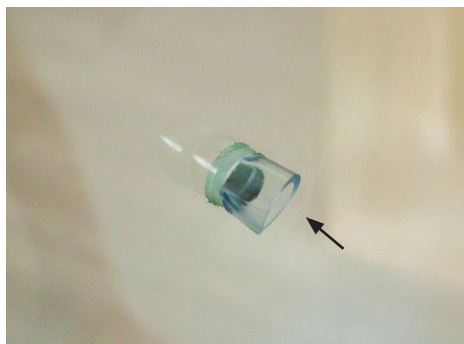

2 viti: 5 x 100 mm



Il foro inferiore della maniglia porta è a un'altezza di 92,5 cm. Le maniglie vengono avvitate tra loro dall'interno.

Fig. 34: Montaggio del magnete della porta

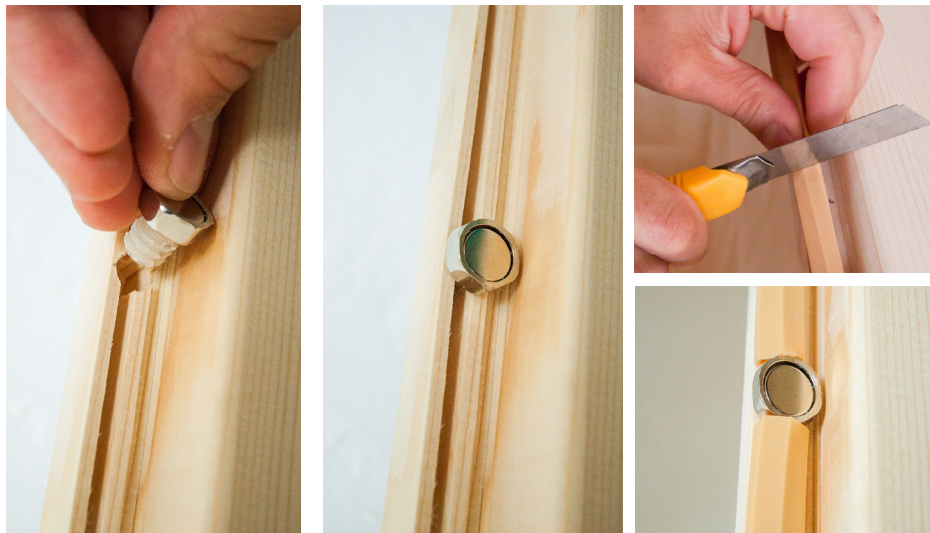

Fig. 35: Montaggio della piastra a scorrimento



5. Pulizia e manutenzione

5.1. Pulizia

ATTENZIONE!

Danni alla cabina

- Non bagnare la cabina e i componenti elettronici con acqua.
- Non pulire la cabina e i componenti elettronici con troppa acqua.

5.2. Manutenzione

La cabina a infrarossi MiniMy non richiede manutenzione.

6. Risoluzione dei problemi

- Qualora si presentassero problemi non trattati in modo esaustivo nelle presenti istruzioni di montaggio, per la vostra sicurezza vi preghiamo di rivolgervi al vostro fornitore.

7. Smaltimento



- Smaltire i materiali dell'imballaggio conformemente alle normative sullo smaltimento vigenti.
- I vecchi dispositivi contengono materiali riciclabili ma anche sostanze dannose. Non gettare mai un dispositivo usato insieme ai rifiuti non riciclabili, bensì smaltirlo in conformità alle norme vigenti a livello locale.

8. Specifiche tecniche

Condizioni ambientali

Temperatura di stoccaggio:	da - 25 °C a + 70 °C
Temperatura ambiente:	da 20 °C a + 30 °C
Umidità dell'aria:	max 95%

9. Pianta

Poiché il legno è un prodotto naturale, sono possibili leggeri scostamenti dimensionali.

9.1. Pianta "Porta a sinistra"

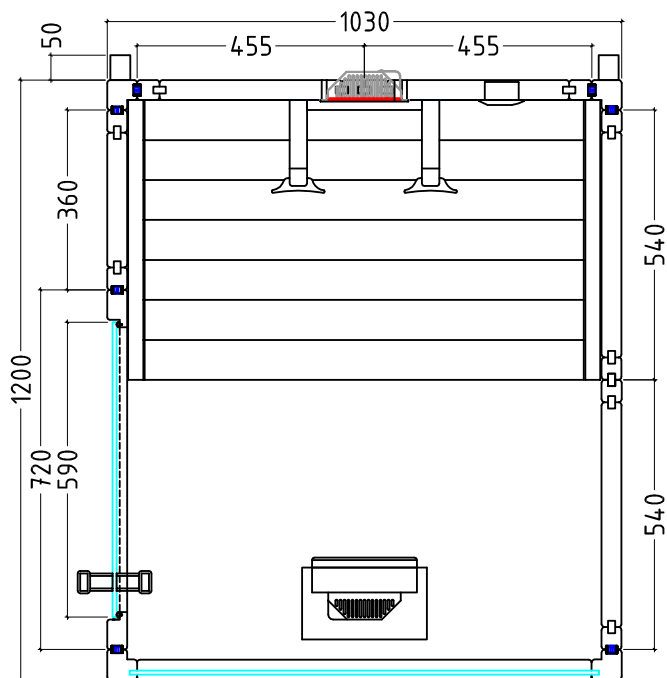

9.2. Pianta "Porta a destra"

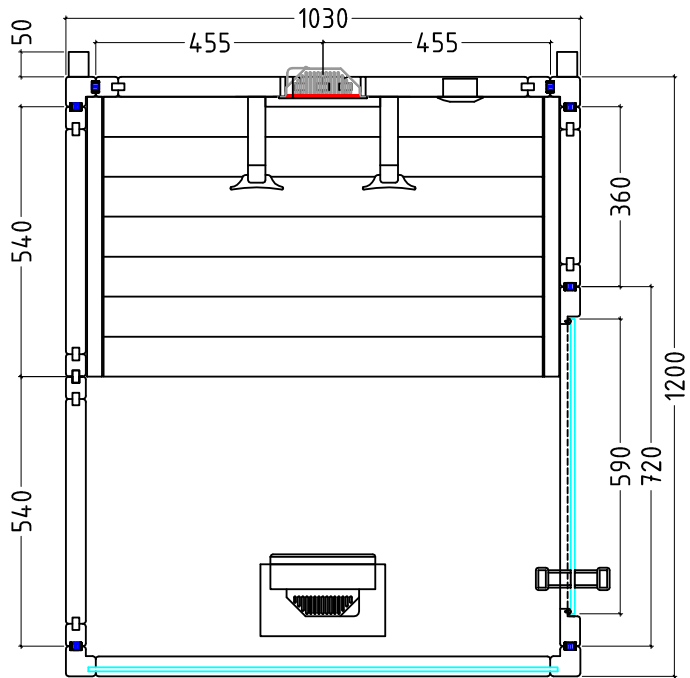

9.3. Differenze di montaggio pianta "Porta a destra"

Per il montaggio dell'elemento in vetro (Pagina 16)

Rimuovere i multclip dall'elemento in vetro e montarli nella posizione segnata usando le dime allegate.

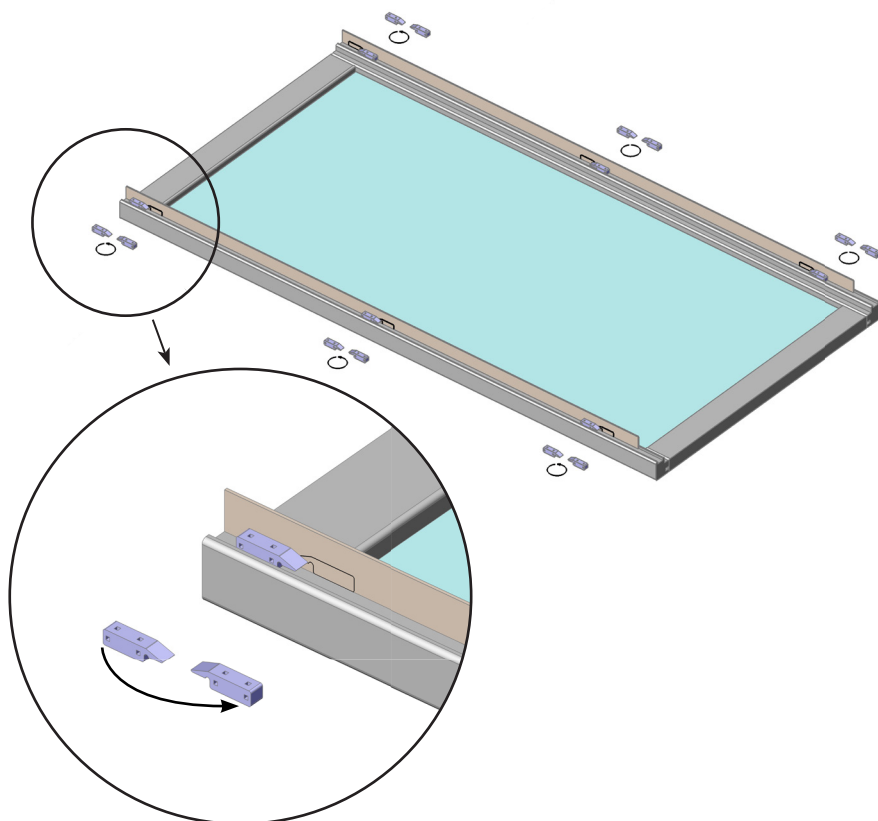

Harvia MiniMy 120 Basic

HARVIA

Infraroodcabine

Montage- en gebruiksaanwijzing

120 x 130 x 202 cm

Artikelnr.

MINIMY-120-B



NL



CE UK
CA

Inhoudsopgave

1. Over deze handleiding	3
2. Belangrijke aanwijzingen voor uw veiligheid	4
2.1. Gebruik volgens de voorschriften	4
2.2. Veiligheidsaanwijzingen	4
3. Productbeschrijving	6
3.1. Omvang van de levering MiniMy	6
3.2. Productfuncties	6
4. Montage van de infraroodcabine MiniMy	7
4.1. Vereist gereedschap	7
4.2. Stuklijst infraroodcabine MiniMy	8
4.3. Montage van de cabine	10
4.4. Montage van de binneninrichting	20
4.5. Montage infraroodstraler en warmteplaat	21
4.6. Montage van de ledlijst	23
4.7. Installatie van de infraroodbesturing	24
4.8. Montage van de bank	27
4.9. Montage van de rugleuningen en hoofdsteunen	28
4.10. Montage van de deuren	30
5. Reiniging en onderhoud	33
5.1. Reiniging	33
5.2. Onderhoud	33
6. Probleemoplossing	33
7. Afvoer	33
8. Technische gegevens	34
9. Plattegrond	34
9.1. Plattegrond „Deur links”	34
9.2. Plattegrond „Deur rechts”	35
9.3. Wijzigingen bij montage plattegrond „Deur rechts”	36

1. Over deze handleiding

Lees deze montage- en gebruiksaanwijzing goed door en bewaar deze in de buurt van de infraroodcabine. Zo kunt u te allen tijde informatie over uw veiligheid en de bediening nalezen.



U vindt deze montage- en gebruiksaanwijzing ook in het downloadbereik van onze website www.mediabank.harvia.com.

Symbolen in waarschuwingsaanwijzingen

In deze montage- en gebruiksaanwijzing staat bij werkzaamheden die gevaarlijk kunnen zijn een waarschuwingsaanwijzing. Neem deze waarschuwingsaanwijzingen steeds in acht. Zo voorkomt u materiële schade, letsel en zelfs de dood.

In de waarschuwingsaanwijzingen worden signaalwoorden gebruikt die de volgende betekenis hebben:



GEVAAR!

Als u deze waarschuwingsaanwijzing niet in acht neemt, leidt dit tot ernstig letsel of de dood.



WAARSCHUWING!

Als u deze waarschuwingsaanwijzing niet in acht neemt, kan dit leiden tot ernstig letsel of de dood.



VOORZICHTIG!

Als u deze waarschuwingsaanwijzing niet opvolgt, kan dit leiden tot licht letsel.

ATTENTIE!

Dit signaalwoord waarschuwt voor materiële schade.

Andere symbolen



Dit symbool kenmerkt tips en nuttige aanwijzingen.



Niet afdekken!

2. Belangrijke aanwijzingen voor uw veiligheid

De infraroodcabine is gebouwd conform de erkende veiligheidstechnische voorschriften. Toch kunnen bij het gebruik gevaren ontstaan. Neem daarom de volgende veiligheidsaanwijzingen en de speciale waarschuwingaanwijzingen in de afzonderlijke hoofdstukken in acht.

2.1. Gebruik volgens de voorschriften

De infraroodcabine is bedoeld voor de verwarming van het menselijk lichaam.

De standplaats van de cabine moet beschermd zijn tegen spatwater. Voor een optimaal gebruik moet de standplaats een omgevingstemperatuur van minstens 20 °C hebben. De maximale luchtvochtigheid in de omgeving mag niet hoger zijn dan 95%.

De cabine moet op een effen vlak worden opgesteld. Er moet een afstand tot de wand van minstens 5 cm worden aangehouden.

Elk ander gebruik geldt als niet-reglementair. Niet-reglementair gebruik kan leiden tot productbeschadiging, ernstig letsel of de dood.

NL

2.2. Veiligheidsaanwijzingen

- Montage- en aansluitwerkzaamheden aan elektrische delen (besturing, straler...) mogen uitsluitend in stroomloze toestand worden uitgevoerd.
- Neem ook de plaatselijke bepalingen op de plaats van opstelling in acht.
- Raadpleeg voor problemen die in de montageaanwijzingen niet uitvoerig genoeg werden behandeld in het belang van uw eigen veiligheid uw leverancier.

- De cabine mag niet door kinderen onder 8 jaar worden gebruikt.
- De cabine mag door kinderen vanaf 8 jaar, door personen met gereduceerde fysieke, sensorische of mentale vaardigheden en door personen met gebrekkige ervaring en kennis onder volgende omstandigheden worden gebruikt:
 - onder toezicht.
 - indien veilig gebruik werd gedemonstreerd en ze de gevaren die kunnen ontstaan, begrijpen.
- Kinderen mogen niet met de cabine spelen.
- Kinderen onder 14 jaar mogen de cabine alleen onder toezicht reinigen.
- De cabine mag niet met stoomreinigers, hogedrukreinigers of spuitwater worden gereinigd.
- Maak in het belang van uw eigen gezondheid geen gebruik van de sauna, indien u onder invloed bent van alcohol, medicamenten of drugs.
- Controleer of er geen brandbare voorwerpen op de verwarmingselementen liggen voordat u de besturing inschakelt.

3. Productbeschrijving

3.1. Omvang van de levering MiniMy

- 1x 1-045-570 / Infraroodcabine MiniMy
- 1x 1-037-357 / Voedingseenheid wave.com4 Infra
- 1x 1-012-222 / Bedieningspaneel wave.com4 Infra
- 1x 1-009-265 / Netaansluitleiding infrarood 2,5 m
- 1x 1-027-788 / Infraroodstraler ECO 500 - donker (voorgemonteerd)-frontstraler
- 1x 1-027-785 / Infraroodstraler ECO 350 - donker - rugstraler
- 1x 1-028-348 / IR-warmteplaat 380 mm x 700 mm, 230 V/100 W (voorgemonteerd)
- 1x 1-037-397 / Schakelaarset IR-warmteplaat (voorgemonteerd)
- 1x 1-028-660 / Ontluchting rond espen 631-A
- 1x 1-028-629 / Speksteenschaal
- 1x 1-052-935/ LED-Set WC4-Infra

3.2. Productfuncties

Infraroodcabine

Massieve cabine van sparrenhout voor de infraroodbestraling van 1 persoon.



Harsbullen gelden niet als reclamatierefen. Omdat in sparrenhout van nature harsbullen kunnen voorkomen en bij het sorteren niet kan worden herkend in welke diepte ze zich bevinden.

Als ze zich net onder het oppervlak bevinden, kunnen ze bij hitte openbreken en gaan „bloeden”.

De uitgelopen hars kan met een in aceton gedompelde doek worden verwijderd. Als alleen harsdruppels ontstaan, deze laten uitharden en met een mes voorzichtig wegschrappen.

Infraroodbesturing wave.com4 Infra

Besturing voor het dimmen van 2 verwarmingskringen met elk maximaal 1,5 kW, en voor het dimmen van licht en een optionele ventilator.



Deze besturing ondersteunt alleen de bedrijfsmodus „Intensiteitsregeling”.

4. Montage van de infraroodcabine MiniMy

Controleer alvorens met de montage te beginnen aan de hand van de stuklijst of alle afzonderlijke delen werden geleverd. Als er delen ontbreken, neem dan uiterlijk 14 dagen na ontvangst van de cabine contact op met uw handelaar.



Voor de montage heeft u een tweede persoon nodig!

Bovendien raden we aan om de gaten voor de schroeven voor te boren.

4.1. Vereist gereedschap

- Hamer en slagbout of een rubberhamer
- Accuschroefmachine met bits voor kruiskopschroeven en torx
- Rolmaat
- Waterpas
- Doorslag of houtblokje 12 mm
- Inbus 1,5 mm

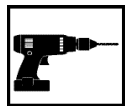

Vorboren



Controle van de rechte hoek:

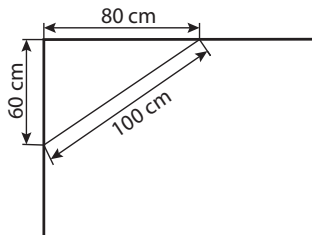

Ga voorzichtig om met glas: Wees extra voorzichtig met de randen van het glas - gehard glas kan bij een botsing in kleine stukjes breken. Plaats een beschermend kussen (bijvoorbeeld: kartonnen doos) onder de rand van het glas.

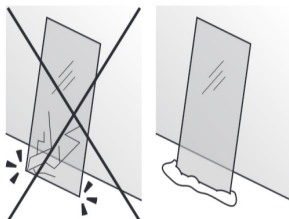

4.2. Stuklijst infraroodcabine MiniMy

Aantal	Benaming	Maat
Bodemframe		
1	Bodemframe achter	103 x 9 x 4 cm
1	Bodemframe rechts	114 x 9 x 4 cm
1	Bodemframe links	42 x 9 x 4 cm
Wandelementen		
2	Wandelement A/A met multclip	193 x 54 x 4 cm
1	Wandelement A/A met multclip	193 x 36 x 4 cm
1	Wandelement A/B met straleruitsparing	193 x 45,5 x 4 cm
1	Wandelement A/B met uitsparing voor straler en bedieningspaneel	193 x 45,5 x 4 cm
1	Glaselement met multclip	202 x 103 x 4 cm
1	Deurframe	202 x 72 x 4 cm
Dakelementen		
1	Dakelement A/B met uitsparing ventilator	107 x 45 x 4 cm
1	Dakelement A/B	107 x 45 x 4 cm
Hoekstaander		
2	Hoekstaander 90°	193 x 6 x 6 cm
Steunlijsten		
1	Daksteunlijst	112 x 4 x 4 cm
1	Daksteunlijst met boring	112 x 4 x 4 cm
1	Daksteunlijst	95 x 4 x 4 cm
1	Daksteunlijst met boring	95 x 4 x 4 cm
1	Banksteun links	41 x 56 x 4 cm
1	Banksteun rechts	41 x 56 x 4 cm

Aantal	Benaming	Maat
Binneninrichting		
1	Stralerkast sparrenhout	105 x 23 x 12 cm
1	IR-warmteplaat incl. rooster	79,8 x 42 x 4,5 cm
1	Bank	94,5 x 56 x 10 cm
2	Ergo-rugleuning	70 x 18 x 10,5 cm
1	Hoofdsteun VitaMy	35 x 27,5 x 8 cm
1	Frame voor straler 350 W lindehout	73,5 x 23 x 2 cm
1	Led-afdeklijst	95 x 3 x 3 cm
1	Bodem sparrenhout	94,4 x 61,8 x 4 cm
Glaselement		
1	Glazen deur	191,5 x 59 x 0,8 cm
Toebehoren		
1	Deurgreepset hout/hout	
1	Deurmagneet, overschuifplaat	
1	2 deurscharnieren 8653-02	
2	Montagelijst voor hoofdsteun	13,5 x 2 x 2 cm
1	Sjabloon voor multclip montage rugleuning	
1	Sjabloon voor multclip montage glazen front	
2	Afstandslijst achterwand	202 x 5 x 4 cm
1	Montagemateriaal	
1	Montagehandleiding	

4.3. Montage van de cabine

De cabine kan „deur links” of „deur rechts” worden opgebouwd. Neem hiervoor de plattegronden op pagina 34 en pagina 35 in acht.

Montage van het bodemframe

Afb. 1: Plaatsen van de drie bodemframe-elementen

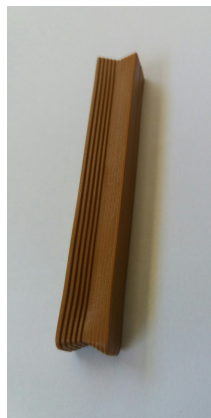

Afb. 2: Bodemframe verbinden

Sla de kunststofverbindingen er voorzichtig met een hamer aan beide hoeken van het bodemframe in tot deze vlak afsluiten met de groef van het element. Gebruik een doorslag of een houten blokje om de kunststofverbinding er goed verzonken in te slaan.

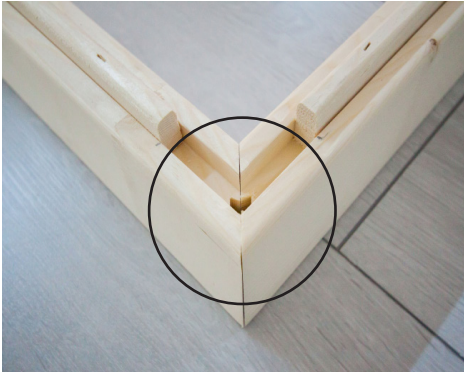
**Montage van de wandelementen**

De hoekstaanders worden door middel van „multiclips” met de wandelementen verbonden. De andere wandelementen zijn met groef en spie verbonden en worden aan elkaar vastgeschroefd.

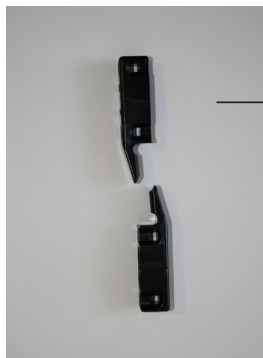
Afb. 3: Multiclips

Hoekstaander

Attentie!

Hieronder wordt de montage voor plattegrond „Deur links” beschreven.
Wijzigingen met betrekking tot de montage voor plattegrond „Deur rechts”
- zie pagina 35.



A duidt altijd op de zichtzijde, dit is op de bovenzijde van de wandelementen gekenmerkt.

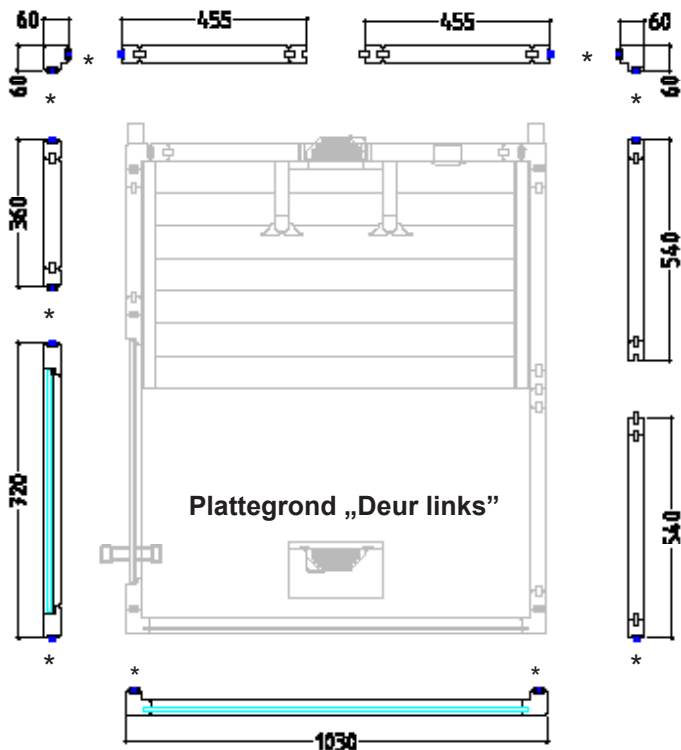

Afb. 4: Wandelementen met hoekstanders verbinden

Steek de hoekstanders van boven naar beneden op de wandelementen. Let hierbij op de correcte uitlijning van de „multiclips” (zie Afb. 44). De hoekstander moet vlak afsluiten met de wandelementen.

Afb. 5: Montage op bodemframe

Afb. 6: Wandelement met uitsparing plaatsen

Nadat u het stralerelement heeft geplaatst, gaat u verder met de tweede hoek.

Afb. 7: Klaar gemonteerde wandelementen

Afb. 8: Vastschroeven van de wandelementen

Controleer de rechte hoek alvorens de wandelementen vast te schroeven.
Let op de tip op pagina 8.



Boormachine 3 mm, 2 stuks schroeven 4 x 70 mm

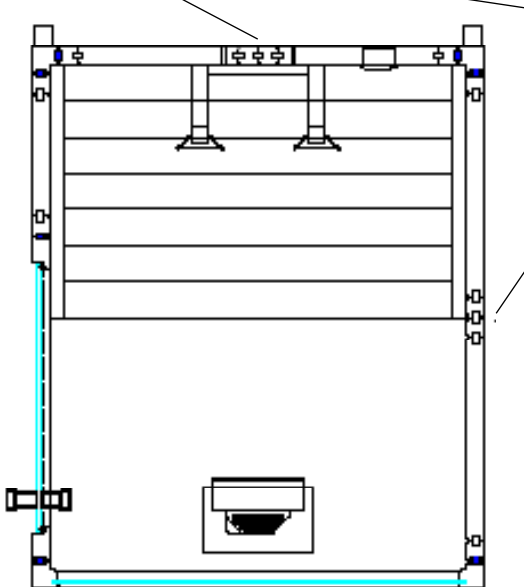

Afb. 9: Montage van het glaselement



NL

Afb. 10: Montage van het deurframe



Montage van de dakelementen



Controleer de rechte hoek alvorens de wandelementen vast te schroeven.
Let op de tip op pagina 8.

Afb. 11: Montage daksteunlijsten

Schroef de daksteunlijsten zoals in Afb. 11 aan alle wanden van de cabine vast. Zorg hierbij voor een vlakke afsluiting van wandelementen en daksteunlijst in een lijn.



16 stuks schroeven: 3,5 x 50 mm



Positie lijst met boring

Afb. 12: Daksteunlijsten

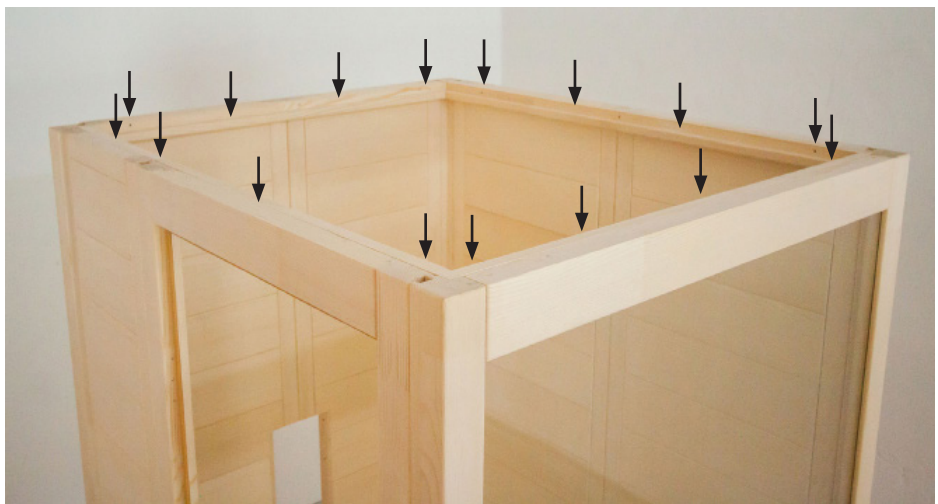

Afb. 13: Plaatsen van dakelement achter met ventilatoruitsparing



Afb. 14: Plaatsen van dakelementen voorzijde



NL

Afb. 15: Bevestigen van de dakelementen

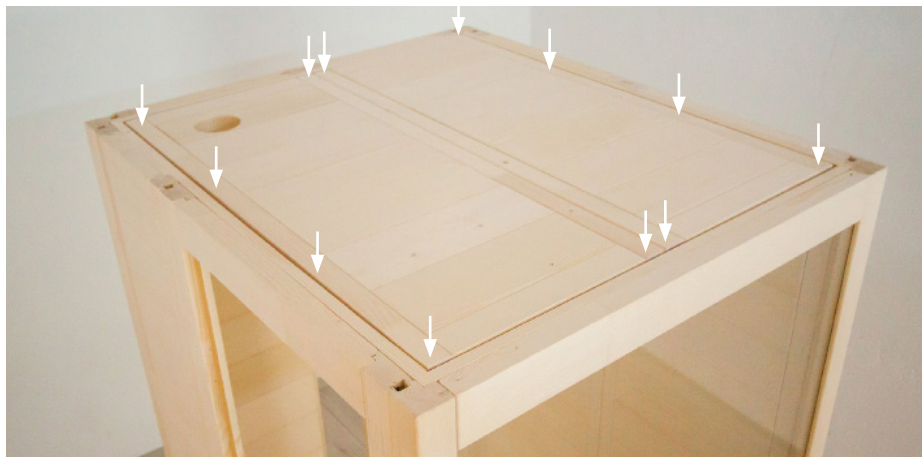

12 stuks schroeven: 3,5 x 35 mm

Afb. 16: Montage afstandslijsten achterwand

Schroef de afstandslijsten aan de achterwand vast, naar keuze vlak afsluitend of tot 10 cm naar binnen verschoven.



Schroeven 4 stuks: 4 x 70

Montage van de ontluchting**Afb. 17: Montage van de ontluchting**

Schroef het basiselement van de ontluchting met de 3 bijgeleverde schroeven vast. Schroef vervolgens het houten bord erin en borg de schroef van buiten met de kunststof kap.

4.4. Montage van de binneninrichting

Afb. 18: Banksteunen monteren



NL

4 stuks schroeven: 4 x 70 mm

4 stuks schroeven: 4 x 70 mm

Afb. 19: Vloer plaatsen

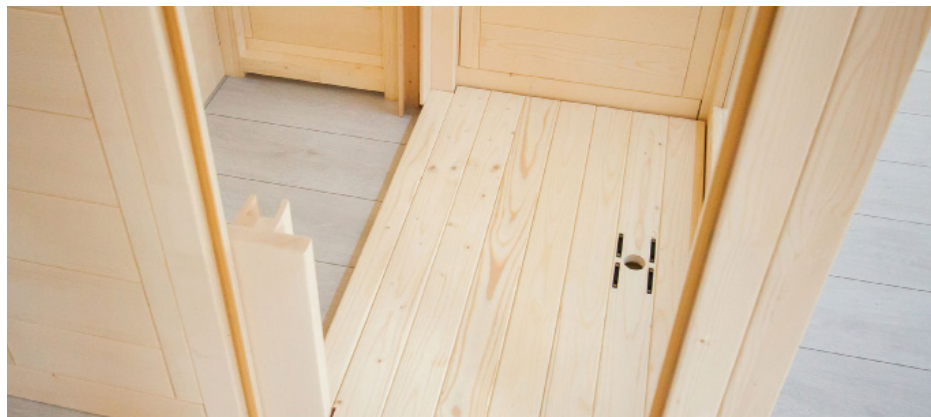

4.5. Montage infraroodstraler en warmteplaat

Afb. 20: Frontstraler fixeren



Zorg ervoor dat de kabels van de frontstraler vrij op de grond liggen en niet door de cabinebodem worden ingeklemd of beschadigd.

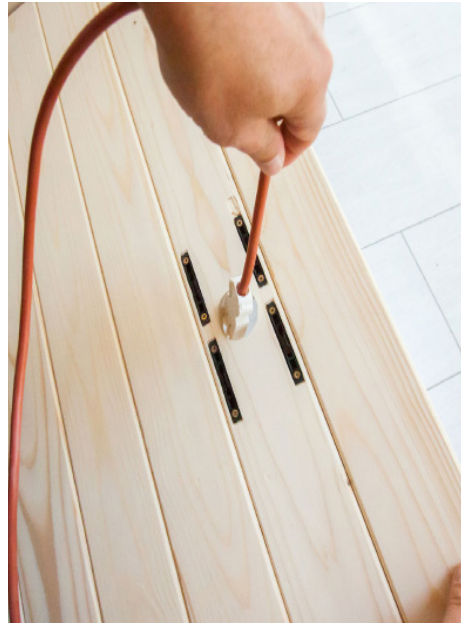

Nadat de straler op de bodem is vergrendeld, fixeert u deze door de inbusschroeven op de vier bevestigingspunten 90° rechtsom te draaien.

Afb. 22: Plaatsen van de speksteenschaal**Afb. 21: Rugstralers (infraroodstraler ECO 350) monteren****VOORZICHTIG!**

Zorg ervoor dat de aansluitkast van de straler aan de bovenzijde is!

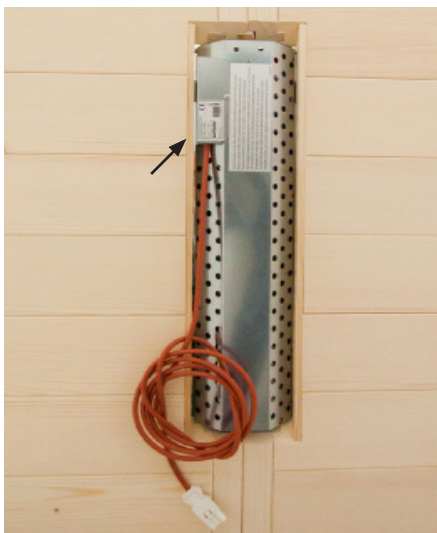

Schroeven 4 stuks: 3 x 18 mm

Plaats de straler van binnen in de uitsparing. Schroef de straler met 4 schroeven vast.

Afb. 23: Plaatsen van de IR-warmteplaat



Voorkom bij het plaatsen van de IR-warmteplaat dat de kabels van de schakelaar worden ingeklemd of beschadigd.



Plaats de IR-warmteplaat in de U-lijsten. De uitsparing is bedoeld als doorvoer voor de leiding van de frontstraler.

NL

4.6. Montage van de ledlijst

Afb. 24: Ledlijst fixeren



Schroeven 3 stuks: 3,5 x 50 mm

Schroef de led-afdeklijst van boven vast (voorgeboord)

4.7. Installatie van de infraroodbesturing

 Neem voor de montage, inbedrijfstelling en bediening de handleiding in acht die bij de besturing wordt geleverd. Door de bijgeleverde besturing wordt alleen de bedrijfsmodus „Intensiteitsregeling” ondersteund.

Aansluiting van de voedingseenheid

De voedingseenheid van de besturing wordt onder de bank van de cabine aangebracht. Leid de netstekker door de opening in de achterwand naar buiten en sluit de leidingen als volgt aan.

Verwarmingsgroep 1: rugstraler, IR-warmteplaat (boven schakelaar)

Verwarmingsgroep 2: frontstraler

Afb. 25: Voorbeeld voor aansluiting

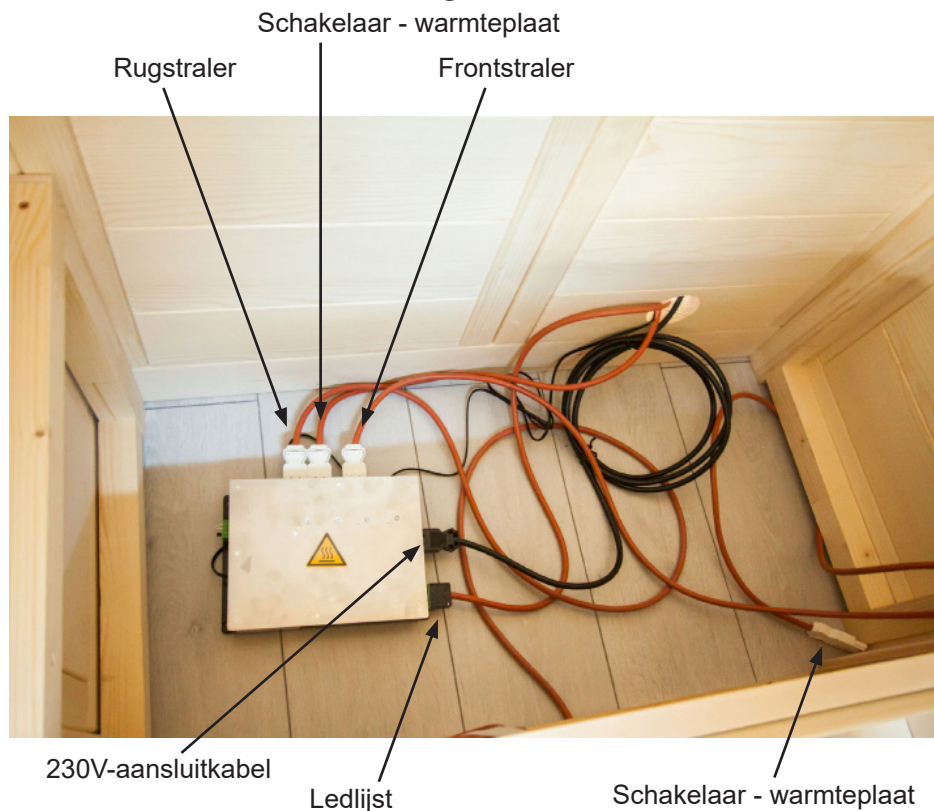

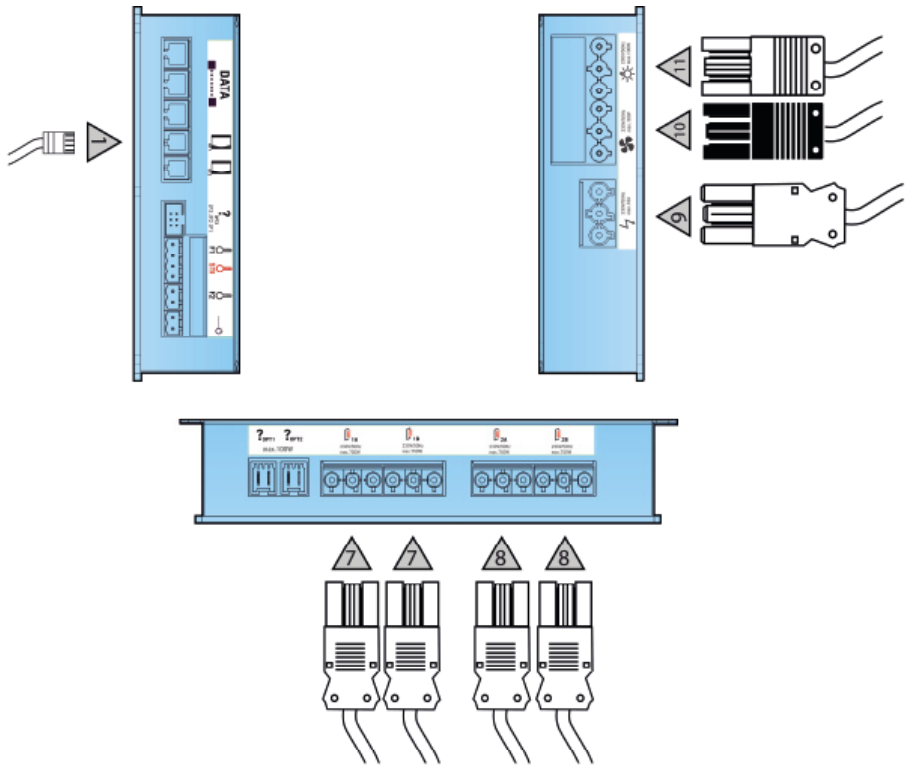
Afb. 26: Aansluitingen voedingseenheid

Stekker	Beschrijving
1	wave.com4 Infra bedieningspaneel
7	IR-verwarmingsgroep 1
8	IR-verwarmingsgroep 2
9	Netaansluiting
10	Ventilator aansluiting (zwart) - optioneel
11	Licht aansluiting (groen)

Aansluiting van de LED RGBW

Afb. 27: Verbinden van de led RGBW met de besturing



Leid de voedingseenheid van de ledverlichting onder de bank. Leid de aansluitleiding en de netstekker door de opening in de achterwand naar buiten.

4.8. Montage van de bank

Nadat de besturing volledig is aangesloten, kan de bank klaar worden gemonteerd.

Afb. 28: Fixeren van de zitbank



2 stuks schroeven: 4 x 70 mm

Plaats de bank op de steunlijsten. Schuif de zitvlakken naar voren.



VOORZICHTIG!

Borg de bank tegen verschuiven met de borgschroeven schuin tegen de achterwand.

4.9. Montage van de rugleuningen en hoofdsteunen

De montage van het frame voor de straler wordt uitgevoerd vanaf de achterzijde (voorgeboord) met 4 stuks schroeven 3,5 x 50 mm. Als dit niet mogelijk is, deze vanaf de voorzijde met schroeven bevestigen (zie afbeelding rechts). Schroef de multiclips met behulp van de montagesjabloon met de 8 schroeven 3,5 x 35 mm vast.

Afb. 29: Montage rugleuningen



NL

Steek vervolgens de rugleuningen van boven naar beneden op de houders tot deze vergrendelen.

Afb. 30: Montage hoofdsteunen

4 stuks schroeven: 3,5 x 35 mm



Schroef de houders aan de zijkant vlak afsluitend met de rugleuningen vast. De hoogte kan naar wens worden gevarieerd. Steek vervolgens de hoofdsteun op de gewenste positie.



4.10. Montage van de deuren

Afb. 31: Montage deurbeslagen 1

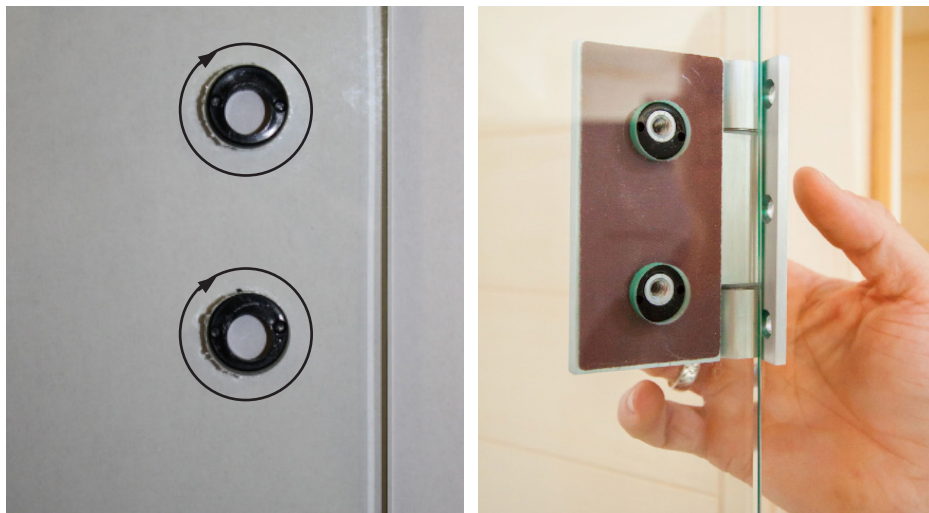

Schroef de twee deurbeslagen vast aan de glazen deur. Zorg hierbij voor een rechte uitlijning van de beslagen. Laat de deur naar buiten openen.

NL

De uitlijning van de beslagen wordt uitgevoerd door de twee kunststofringen te draaien.

Afb. 32: Montage deurbeslagen 2



Afb. 33: Montage deurgreep

Plaats eerst de twee silicone vulstukken in de boringen voor de deurgreep op het glaselement. Schroef de twee grepen daarna voorzichtig aan elkaar.

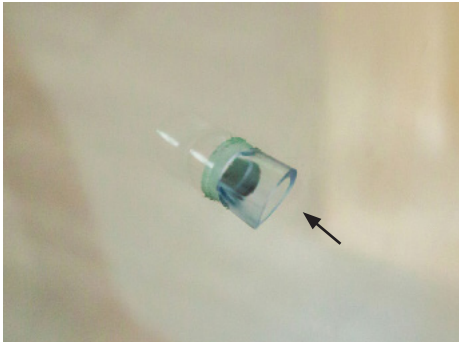

2 stuks schroeven: 5 x 100 mm



De onderste boring van de deurgreep bevindt zich op 92,5 cm hoogte. De deurgrepen worden van binnen aan elkaar vastgeschroefd.

Afb. 34: Montage deurmagneet

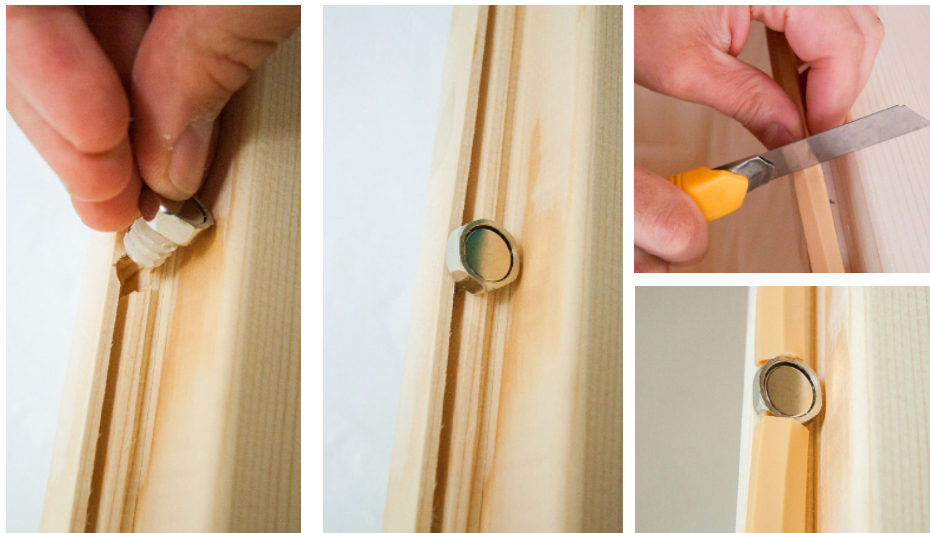

Afb. 35: Montage overschuifplaat



5. Reiniging en onderhoud

5.1. Reiniging

ATTENTIE!

Beschadiging van de cabine

- Giet geen water over de cabine en de elektronische componenten.
- Reinig de cabine en de elektronische componenten niet te vochtig.

5.2. Onderhoud

De infraroodcabine MiniMy is onderhoudsvrij.

6. Probleemoplossing

- Raadpleeg voor problemen die in de montageaanwijzingen niet uitvoerig genoeg werden behandeld in het belang van uw eigen veiligheid uw leverancier.

7. Afvoer



- Voer het verpakkingsmateriaal af volgens de geldende afvoer-richtlijnen.
- Oude apparaten bevatten opnieuw bruikbare materialen maar ook schadelijke stoffen. Deponeer uw oude apparaat daarom in geen geval bij het gewone afval, maar voer het apparaat af volgens de plaatselijk geldende voorschriften.

8. Technische gegevens

Omgevingsomstandigheden

Opslagtemperatuur:	-25 °C tot +70 °C
Omgevingstemperatuur:	20 °C tot +30 °C
Luchtvochtigheid:	max. 95%

9. Plattegrond

Omdat hout een natuurproduct is, zijn geringe maatafwijkingen mogelijk.

9.1. Plattegrond „Deur links”

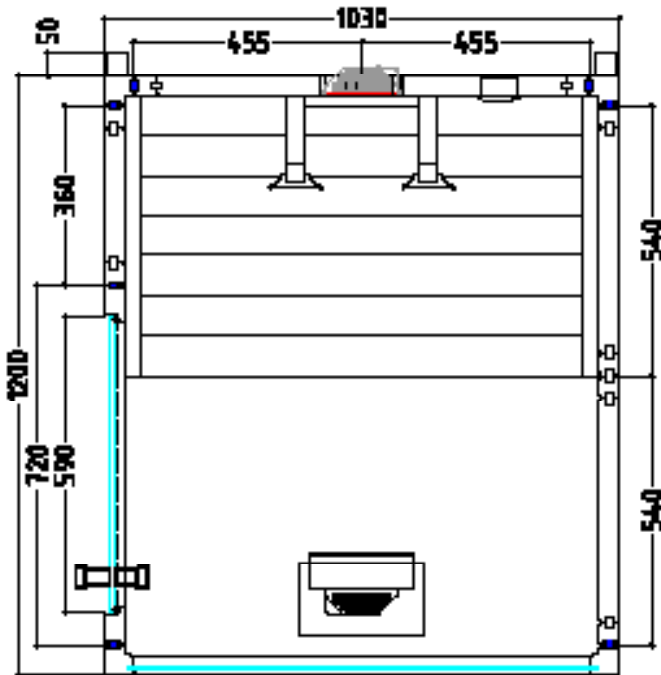

9.2. Plattegrond „Deur rechts”

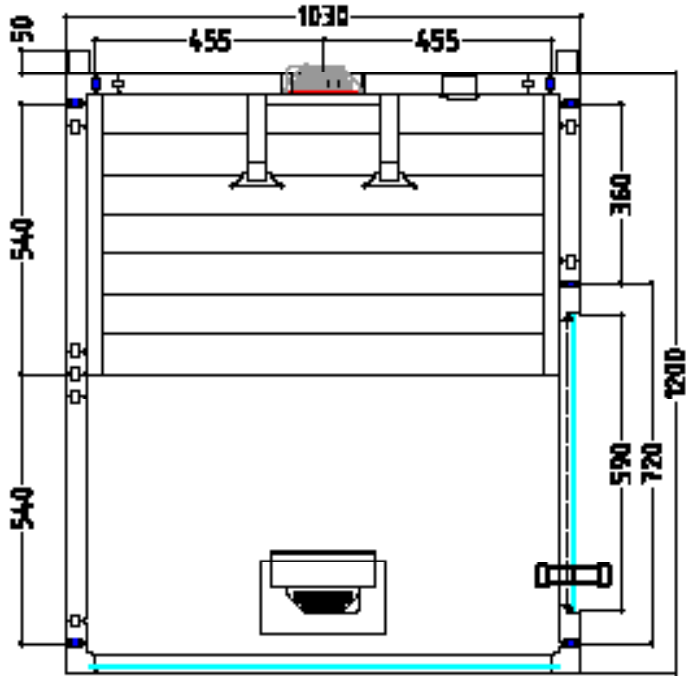

9.3. Wijzigingen bij montage plattegrond „Deur rechts”

Voor de montage van het glaselement (pagina 16)

Verwijder de multiclips bij het glaselement en monteer deze met de bijgeleverde sjablonen op de gemarkeerde positie.

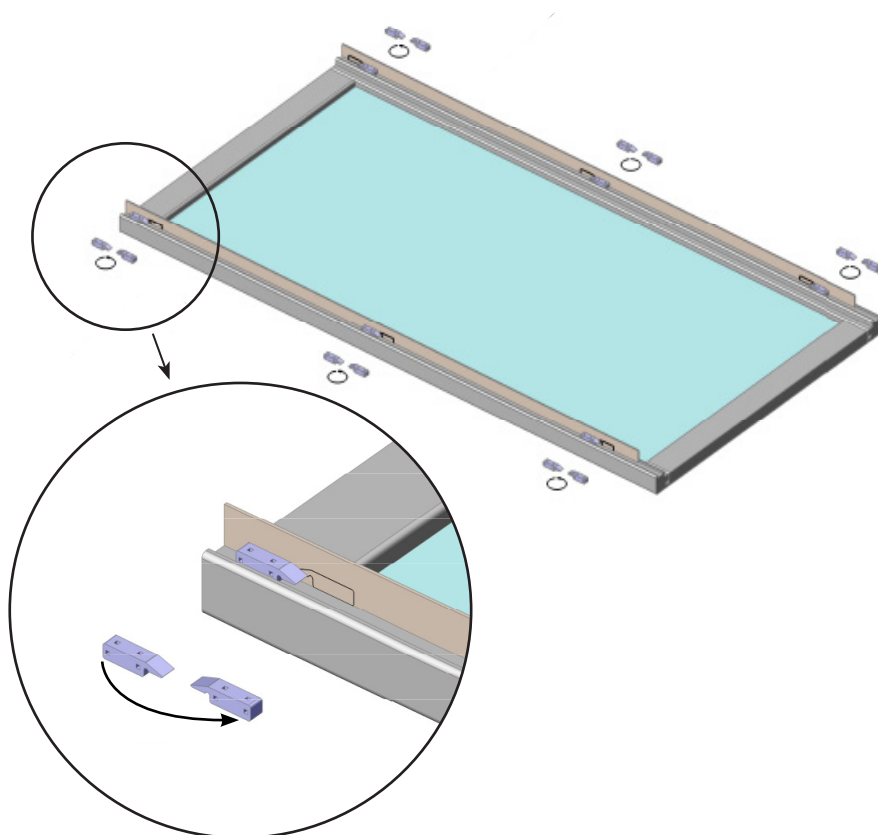

Harvia MiniMy 120 Basic

HARVIA

Cabina de infravermelhos
Manual de montagem e operação

120 x 130 x 202 cm

N.º de artículo
MINIMY-120-B



PT



**CE UK
CA**

Índice

1. Sobre este manual	3
2. Indicações importantes sobre a sua segurança	4
2.1. Utilização prevista	4
2.2. Indicações de segurança	4
3. Descrição do produto	6
3.1. Volume de fornecimento da MiniMy	6
3.2. Funções do produto	6
4. Montagem da cabina de infravermelhos MiniMy	7
4.1. Ferramentas necessárias	7
4.2. Lista de peças da cabina de infravermelhos MiniMy	8
4.3. Montagem da cabina	10
4.4. Montagem do equipamento interior	20
4.5. Montagem do radiador de infravermelhos e da placa de aquecimento	21
4.6. Montagem da barra LED	23
4.7. Instalação do comando de infravermelhos	24
4.8. Montagem do banco	27
4.9. Montagem dos encostos e apoios de cabeça	28
4.10. Montagem da porta	30
5. Limpeza e manutenção	33
5.1. Limpeza	33
5.2. Manutenção	33
6. Resolução de problemas	33
7. Eliminação	33
8. Dados técnicos	34
9. Plano	34
9.1. Plano “porta à esquerda”	34
9.2. Plano “porta à direita”	35
9.3. Alterações na montagem do plano “porta à direita”	36

1. Sobre este manual

Leia atentamente este manual de montagem e operação e guarde-o nas proximidades da cabina de infravermelhos. Desta forma, pode ler as informações sobre a sua segurança e a operação a qualquer momento.



Este manual de montagem e operação também está disponível na área de transferências do nosso website em www.mediabank.harvia.com.

Símbolos nas advertências

Neste manual de montagem e operação, as atividades que comportam riscos são precedidas de uma advertência. É imperativo que respeite estas advertências. Desta forma, evita danos materiais e ferimentos que, no pior dos casos, podem ser fatais.

Nas advertências são utilizadas palavras de sinalização que têm os significados seguintes:



PERIGO!

A inobservância desta advertência resulta em ferimentos graves ou morte.



AVISO!

A inobservância desta advertência pode resultar em ferimentos graves ou morte.



CUIDADO!

A inobservância desta advertência pode resultar em ferimentos ligeiros.

ATENÇÃO!

Esta palavra de sinalização alerta-o para danos materiais.

Outros símbolos



Este símbolo identifica dicas e indicações úteis.



Não tapar!

2. Indicações importantes sobre a sua segurança

A cabina de infravermelhos foi construída de acordo com as regras de segurança técnicas reconhecidas. No entanto, podem surgir situações de perigo durante a utilização. Por conseguinte, respeite as indicações de segurança e as advertências específicas dos vários capítulos.

2.1. Utilização prevista

A cabina de infravermelhos destina-se ao aquecimento do corpo humano.

O local de instalação da cabina deve estar protegido contra salpicos de água. Para um funcionamento ideal, a temperatura ambiente do local de instalação deve ser de, pelo menos, 20 °C. A humidade atmosférica máxima não deve exceder os 95%.

A cabina deve ser instalada sobre uma superfície plana.

Qualquer utilização que não corresponda à utilização prevista é considerada incorreta. Uma utilização incorreta pode levar a danos no produto, a ferimentos graves ou mesmo à morte.

PT

2.2. Indicações de segurança

- Os trabalhos de montagem e de ligação a componentes eléctricos (comando, radiador, etc.) só podem ser realizados se estes estiverem isentos de tensão.
- Respeite também as regulamentações locais no local de instalação.
- Para sua própria segurança, em caso de problemas que não sejam abordados de forma suficientemente detalhada nas instruções de montagem, contacte os seus fornecedores.

- A cabina não pode ser utilizada por crianças com menos de 8 anos.
- A cabina pode ser utilizada por crianças com mais de 8 anos, por pessoas com capacidades físicas, sensoriais ou mentais reduzidas e por pessoas com falta de experiência e conhecimentos, nas seguintes condições:
 - se forem supervisionadas.
 - Se aprenderem como se utiliza o aparelho de uma forma segura e compreenderem os potenciais riscos.
- As crianças não podem brincar com a cabina.
- Crianças com menos de 14 anos só podem limpar a cabina se forem supervisionadas.
- A cabina não pode ser limpa com dispositivos de limpeza a vapor, equipamentos de lavagem a alta pressão ou jato de água.
- Se estiver sob a influência de álcool, medicamentos ou drogas, não deve tomar banhos de sauna por motivos de saúde.
- Antes de ligar o comando, certifique-se de que não existem quaisquer objetos inflamáveis sobre os elementos de aquecimento.

3. Descrição do produto

3.1. Volume de fornecimento da MiniMy

- 1x 1-045-570/Cabina de infravermelhos MiniMy
- 1x 1-037-357/Unidade de potência wave.com4 Infra
- 1x 1-012-222/Unidade de comando wave.com4 Infra
- 1x 1-009-265/Cabo de alimentação de infravermelhos de 2,5 m
- 1x 1-027-788/Radiador de infravermelhos ECO 500 - escuro (pré-montado) - radiador frontal
- 1x 1-027-785/Radiador de infravermelhos ECO 350 - escuro - radiador traseiro
- 1x 1-028-348/Placa de aquecimento por IV de 380 mm x 700 mm, 230 V/100 W (pré-montada)
- 1x 1-037-397/Conjunto de interruptores da placa de aquecimento por IV (pré-montados)
- 1x 1-028-660/Ventilação redonda em choupo 631-A
- 1x 1-028-629/Concha em pedra-sabão
- 1x 1-052-935/ LED-Set WC4-Infra

3.2. Funções do produto

Cabina de infravermelhos

PT

Cabina maciça em madeira de abeto para a irradiação por infravermelhos de 1 pessoa.



As cavidades com resina não são qualquer motivo de reclamação, uma vez que estas surgem de forma recorrente na madeira de abeto e não é possível detetar, no momento da separação, a profundidade a que se encontram.

Quando estas se encontram pouco abaixo da superfície, emergem com a formação de calor e começam a “sangrar”.

Remover as fugas de resina com um pano embebido em acetona. Se surgirem apenas gotas de resina, deixe-as secar e, depois, raspe-as cuidadosamente com uma faca.

Comando de infravermelhos wave.com4 Infra

Comando para regular 2 circuitos de aquecimento com, no máximo, 1,5 W cada e para regular a luz e um ventilador opcional.



Este comando suporta exclusivamente o modo de operação “Regulação de intensidade”.

4. Montagem da cabina de infravermelhos MiniMy

Antes de começar a trabalhar, verifique, com base na lista de peças, se todas as peças individuais foram efetivamente fornecidas. Se, excepcionalmente, faltarem peças individuais, informe o seu distribuidor num período máximo de 14 dias após a receção da cabina.



Para a montagem é necessária uma pessoa auxiliar!

Recomendamos ainda que realize a perfuração prévia dos furos para os parafusos.

4.1. Ferramentas necessárias

- Martelo e madeira suplementar ou um martelo de borracha
- Aparafusadora sem fios com pontas para parafusos em cruz e Torx
- Rolo de fita métrica
- Nível de bolha de ar
- Punção ou bloco de madeira de 12 mm
- Chave Allen de 1,5 mm



Perfuração prévia



Verificação do ângulo reto:

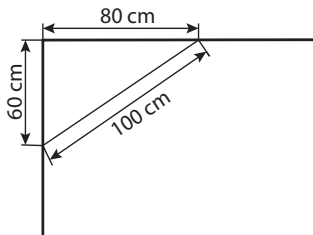

Manusear o vidro com cuidado: ter especial cuidado com as bordas do vidro. Em caso de impacto, o vidro temperado pode partir-se em pequenos fragmentos. Coloque um amortecedor de proteção (por exemplo: o cartão da embalagem) por baixo da borda do vidro.

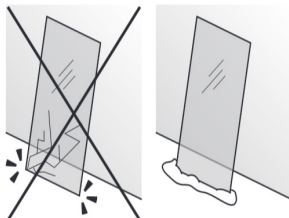

4.2. Lista de peças da cabina de infravermelhos MiniMy

Quant.	Designação	Medida
Armação do chão		
1	Armação do chão traseira	103 x 9 x 4 cm
1	Armação do chão direita	114 x 9 x 4 cm
1	Armação do chão esquerda	42 x 9 x 4 cm
Elementos de parede		
2	Elemento de parede A/A com multiclipse	193 x 54 x 4 cm
1	Elemento de parede A/A com multiclipse	193 x 36 x 4 cm
1	Elemento de parede A/B com abertura para o radiador	193 x 45,5 x 4 cm
1	Elemento de parede A/B com abertura para radiador e unidade de comando	193 x 45,5 x 4 cm
1	Elemento de vidro com multiclipse	202 x 103 x 4 cm
1	Moldura de porta	202 x 72 x 4 cm
Elementos do teto		
1	Elemento de teto A/B com abertura para ventilador	107 x 45 x 4 cm
1	Elemento de teto A/B	107 x 45 x 4 cm
Suportes de canto		
2	Suporte de canto 90°	193 x 6 x 6 cm
Barras de apoio		
1	Barra de apoio do teto	112 x 4 x 4 cm
1	Barra de apoio para o teto com furo	112 x 4 x 4 cm
1	Barra de apoio do teto	95 x 4 x 4 cm
1	Barra de apoio para o teto com furo	95 x 4 x 4 cm
1	Apoio do banco esquerdo	41 x 56 x 4 cm
1	Apoio do banco direito	41 x 56 x 4 cm

Quant.	Designação	Medida
Equipamento interior		
1	Caixa de radiador em abeto	105 x 23 x 12 cm
1	Placa de aquecimento por IV incl. grelha	79,8 x 42 x 4,5 cm
1	Banco	94,5 x 56 x 10 cm
2	Encosto ergonómico	70 x 18 x 10,5 cm
1	Apoio de cabeça VitaMy	35 x 27,5 x 8 cm
1	Moldura para radiador de 350 W em tília	73,5 x 23 x 2 cm
1	Barra de cobertura LED	95 x 3 x 3 cm
1	Chão em abeto	94,4 x 61,8 x 4 cm
Elemento de vidro		
1	Porta de vidro	191,5 x 59 x 0,8 cm
Acessórios		
1	Conjunto de puxadores da porta em madeira	
1	Íman da porta, chapa de transferência	
1	2 dobradiças de porta 8653-02	
2	Barra de montagem para apoio de cabeça	13,5 x 2 x 2 cm
1	Molde para multiclipse de montagem do encosto	
1	Molde para multiclipse de montagem da porta envidraçada	
2	Barra distanciadora para parede traseira	202 x 5 x 4 cm
1	Material de montagem	
1	Manual de montagem	

4.3. Montagem da cabina

A cabina pode ser montada com “porta à esquerda” ou “porta à direita”. A este respeito, tenha em atenção os planos nas páginas Página 33 e Página 34.

Montagem da armação do chão

Fig. 1: Instalação dos três elementos da armação do chão

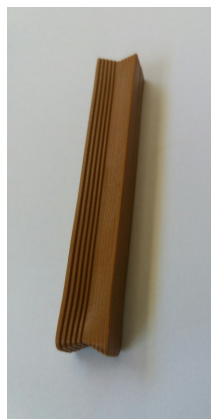

Fig. 2: Unir a armação do chão

Introduza os encaixes de plástico nos dois cantos da armação do chão batendo cuidadosamente com um martelo até os cantos ficarem nivelados com a ranhura do elemento.

Utilize um punção ou um bloco de madeira para introduzir corretamente o encaixe de plástico.

**Montagem dos elementos de parede**

Os suportes de canto são ligados aos elementos de parede através de “multicliques”. Os outros elementos de parede são ligados por meio de ranhuras e molas e aparafusados uns aos outros.

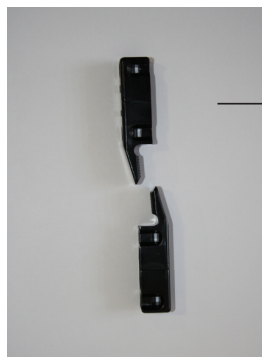
Fig. 3: Multicliques

— Suportes de canto

Atenção!

De seguida, é descrita a montagem para o plano “porta à esquerda”.
Para alterações relativas à montagem para o plano “porta à direita”
- consulte Página 34.



A designa sempre o lado visível. Este está identificado na parte superior dos elementos de parede.

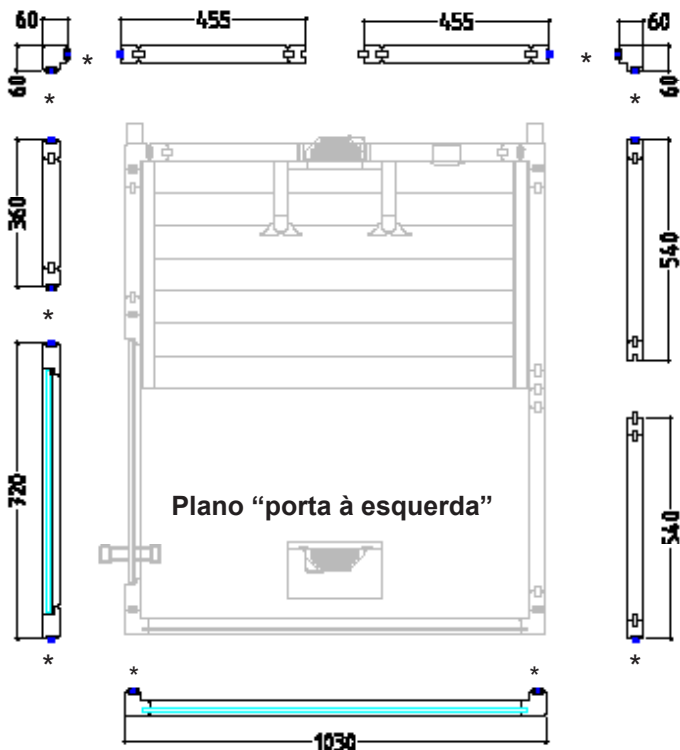

* Multiclipes

Fig. 4: Unir os elementos de parede aos suportes de canto

Insira o suporte de canto nos elementos de parede, de cima para baixo. Ao fazê-lo, tenha em atenção o alinhamento correto dos “multiclipes” (ver Fig. 4). O suporte de canto tem de ficar alinhado com os elementos de parede.

Fig. 5: Montagem na armação do chão

Fig. 6: Instalar o elemento de parede com abertura

Depois de ter instalado o elemento do radiador, prossiga com o segundo canto.

Fig. 7: Elementos de parede montados

Fig. 8: Aparafusamento dos elementos de parede

Verifique os ângulos direitos antes de aparafusar os elementos de parede. Tenha em atenção a dica na Página 8.



Broca de 3 mm, 2 parafusos de 4 x 70 mm

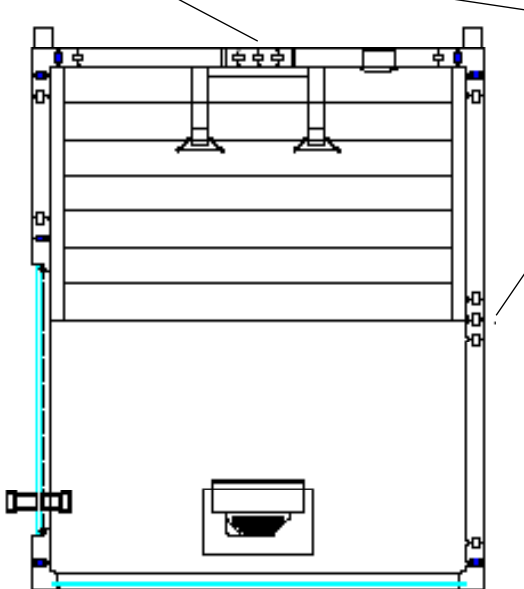

Fig. 9: Montagem do elemento de vidro



Fig. 10: Montagem da moldura de porta



Montagem dos elementos de teto



Verifique os ângulos direitos antes de aparafusar os elementos de parede. Tenha em atenção a dica na Página 8.

Fig. 11: Montagem das barras de apoio para o teto

Aparafuse as barras de apoio para o teto em todas as paredes da cabina conforme ilustrado na Fig. 11. Ao fazê-lo, certifique-se de que as barras de apoio para o teto estão completamente encaixadas nos elementos de parede.

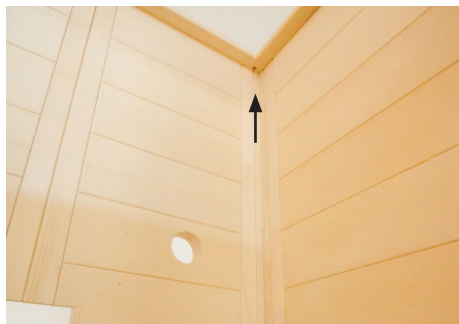

16 parafusos: 3,5 x 50 mm

Posição da barra com furo

Fig. 12: Barras de apoio para o teto



Fig. 13: Inserção do elemento de teto traseiro com abertura de ventilação

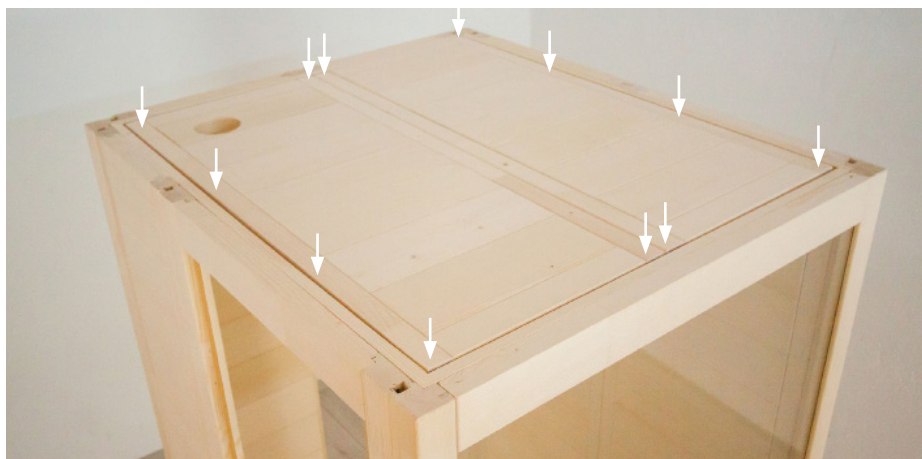

Fig. 14: Inserção dos elementos de teto da frente



PT

Fig. 15: Fixação dos elementos de teto



12 parafusos: 3,5 x 35 mm

Fig. 16: Montagem das barras distanciadoras na parede traseira

Aparafuse as barras distanciadoras à parede traseira, niveladas ou com um desvio de até 10 cm para dentro.

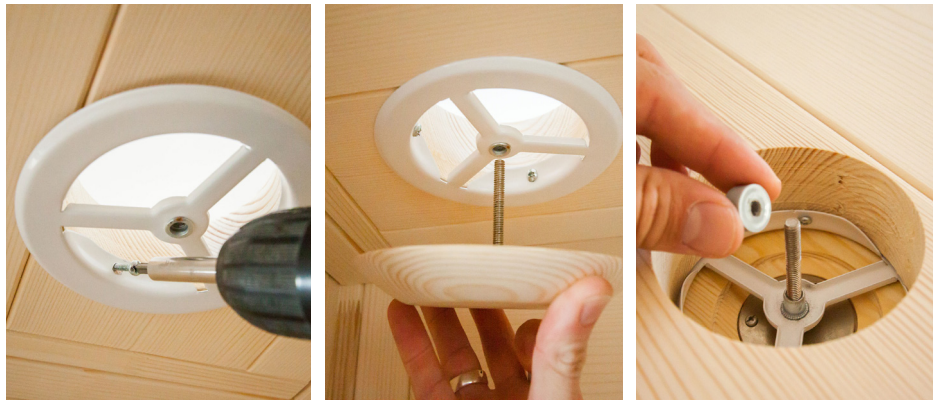

Parafusos, 4 unidades: 4 x 70

Montagem da ventilação**Fig. 17: Montagem da ventilação**

Aparafuse o elemento de base da ventilação com os 3 parafusos fornecidos. A seguir, aparafuse o prato de madeira e fixe o parafuso a partir do exterior com a tampa de plástico.

4.4. Montagem do equipamento interior

Fig. 18: Montar os apoios do banco



PT

4 parafusos: 4 x 70 mm

4 parafusos: 4 x 70 mm

Fig. 19: Inserir o piso

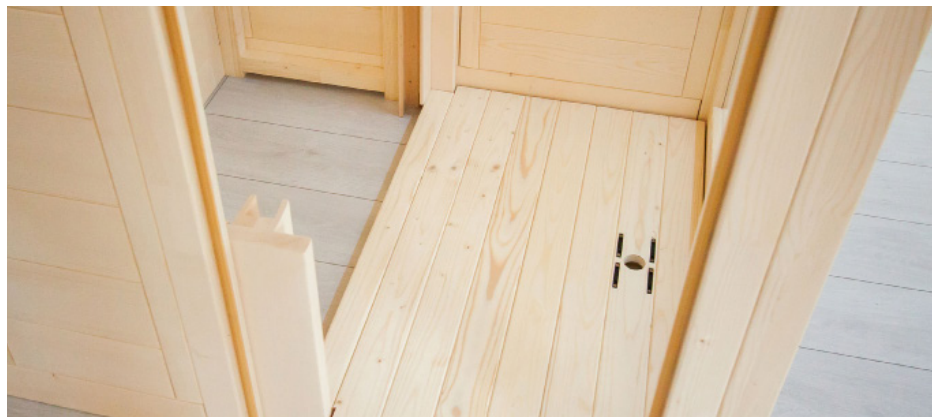

4.5. Montagem do radiador de infravermelhos e da placa de aquecimento

Fig. 20: Fixar o radiador frontal



Certifique-se de que os cabos do radiador frontal ficam livres sobre o chão e não são entalados ou danificados pelo chão da cabina.

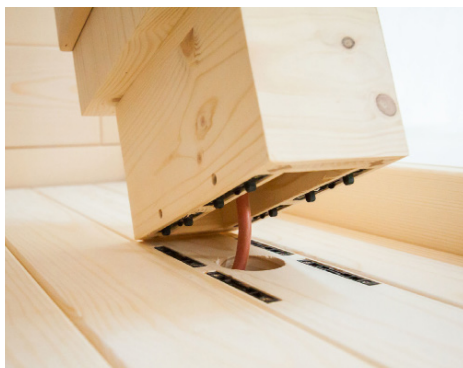

Depois de encaixar o radiador no chão, fixe-o rodando a chave Allen 90° no sentido dos ponteiros do relógio nos quatro pontos de fixação.

Fig. 22: Inserção da concha em pedra-sabão**Fig. 21: Montar o radiador traseiro (radiador de infravermelhos ECO 350)****CUIDADO!**

Certifique-se de que a caixa de ligação do radiador fica na parte superior!

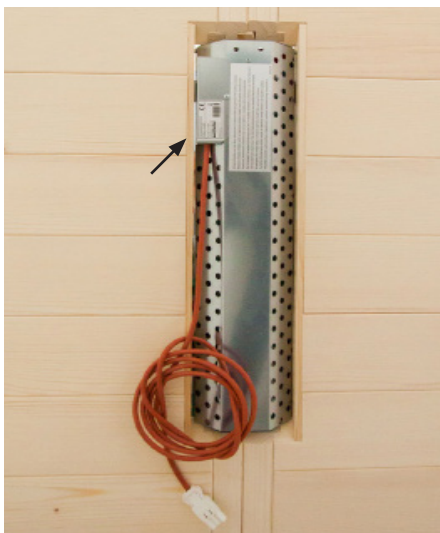

PT

Parafusos, 4 unidades: 3 x 18 mm

Encaixe o radiador na abertura a partir do interior. Aparafuse o radiador com 4 parafusos.

Fig. 23: Instalação da placa de aquecimento por IV

Ao instalar a placa de aquecimento por IV, certifique-se de que os cabos do interruptor não são entalados ou danificados.



Instale a placa de aquecimento por IV nas barras em U. O entalhe destina-se à introdução do cabo do radiador frontal.

4.6. Montagem da barra LED

PT

Fig. 24: Fixar a barra LED

Parafusos, 3 unidades: 3,5 x 50 mm

Aparafuse a barra de cobertura LED a partir de cima (pré-furada)

4.7. Instalação do comando de infravermelhos

 Para a montagem, colocação em funcionamento e operação, observe o manual que acompanha o comando. O comando fornecido suporta exclusivamente o modo de operação “Regulação de intensidade”.

Ligação da secção de potência

A secção de potência do comando é colocada debaixo do banco da cabina. Introduza o conector de alimentação na abertura da parede traseira até ao exterior e ligue os cabos da seguinte forma.

Grupo de aquecimento 1: radiador traseiro, placa de aquecimento por IV (através de interruptor)

Grupo de aquecimento 2: radiador frontal

Fig. 25: Exemplo de ligação

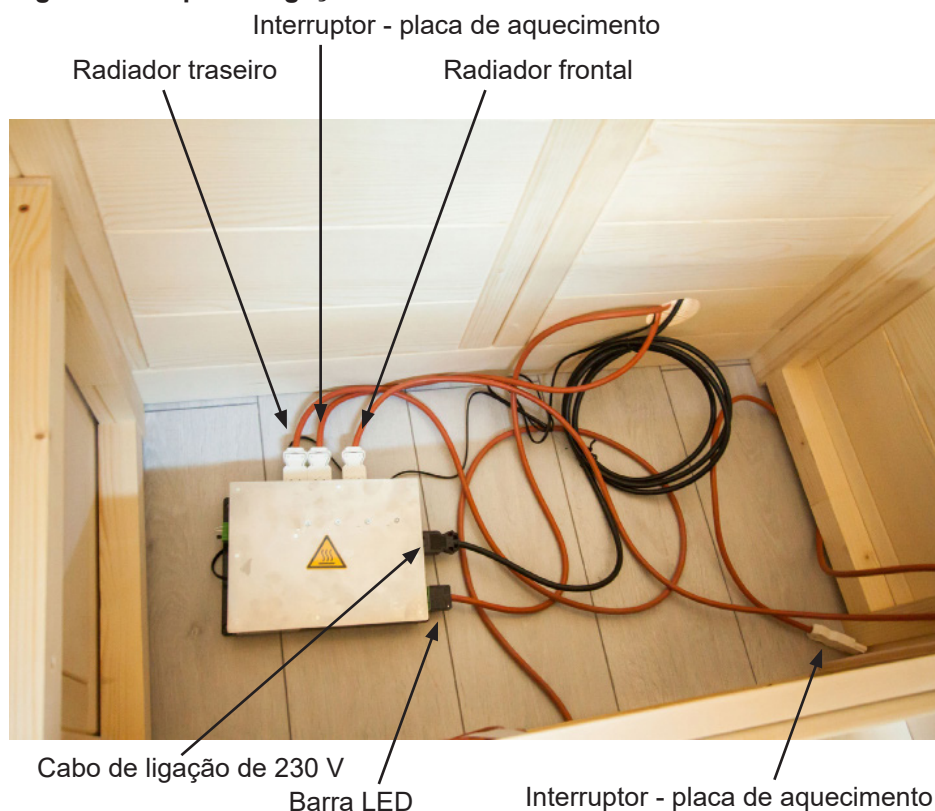
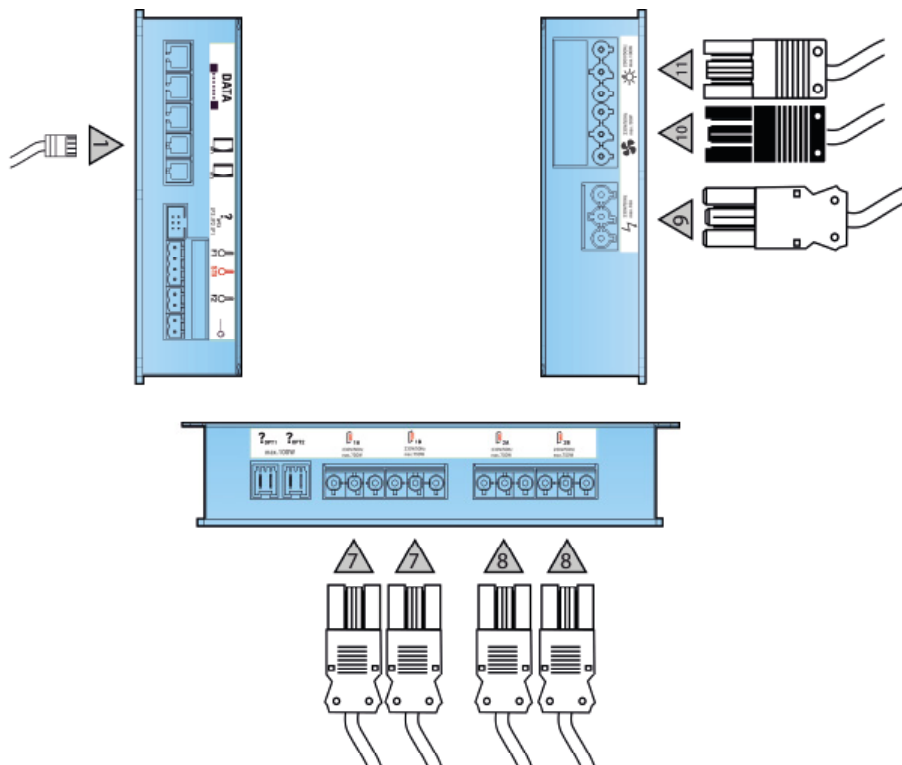

Fig. 26: Ligações da secção de potência

Conector	Descrição
1	Unidade de comando wave.com4 Infra
7	Grupo de aquecimento por IV 1
8	Grupo de aquecimento por IV 2
9	Ligação à rede elétrica
10	Ligação do ventilador (preto) - opcional
11	Ligação da luz (verde)

Ligação da LED RGBW

Fig. 28: Conexão da tira LED ao comando



Coloque o dimmer sob a bancada. Insira o cabo de conexão e o conector de alimentação na abertura da parede traseira o máximo possível.

4.8. Montagem do banco

Uma vez realizada a ligação do comando, o banco pode ser montado.

Fig. 27: Fixação do banco



Coloque o banco sobre as barras de apoio. Empurre a superfície de assento para a frente.



CAUIDADO!

Para evitar que o banco deslize, fixe-o com os parafusos de bloqueio na diagonal em relação à parede traseira.

4.9. Montagem dos encostos e apoios de cabeça

A moldura do radiador é montada na parte traseira (pré-furada) com 4 parafusos de 3,5 x 50 mm. No caso de tal não ser possível, fixe-a com os parafusos a partir da frente (ver imagem da direita).

Com a ajuda do molde de montagem, aparafuse os multicliques com os 8 parafusos de 3,5 x 35 mm.

Fig. 29: Montagem dos encostos



PT

Por último, insira os encostos de cima para baixo nos suportes até encaixarem.

Fig. 30: Montagem dos apoios de cabeça

4 parafusos: 3,5 x 35 mm

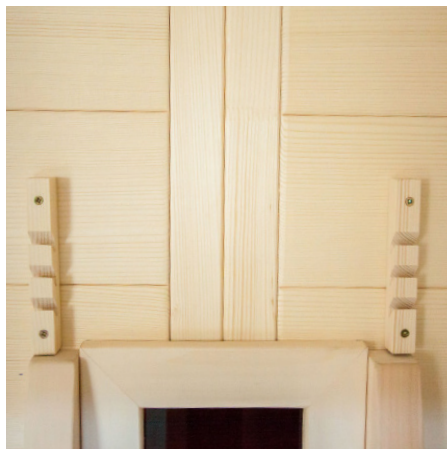

Aparafuse os suportes de forma a ficarem alinhados lateralmente com os encostos. A altura pode ser ajustada conforme desejado. Finalmente, insira o apoio de cabeça na posição desejada.



4.10. Montagem da porta

Fig. 31: Montagem das ferragens da porta 1



Aparafuse as duas ferragens à porta de vidro, certificando-se de que ficam alinhadas de forma reta e de que a porta abre para fora.

 O alinhamento das ferragens é efetuado através do ajuste/rotação de ambos os anéis de plástico.

PT

Fig. 32: Montagem das ferragens da porta 2



Fig. 33: Montagem do puxador da porta

Em primeiro lugar, introduza os dois encaixes de silicone nos orifícios para o puxador da porta no elemento de vidro. A seguir, parafuse com cuidado os dois puxadores entre si.

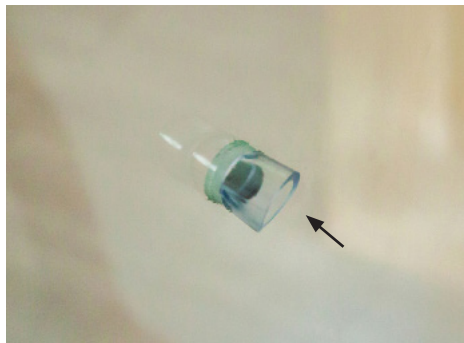

2 parafusos: 5 x 100 mm



PT

O furo inferior do puxador da porta encontra-se a 92,5 cm de altura. Os puxadores da porta são aparafusados entre si pelo interior.

Fig. 34: Montagem do íman da porta

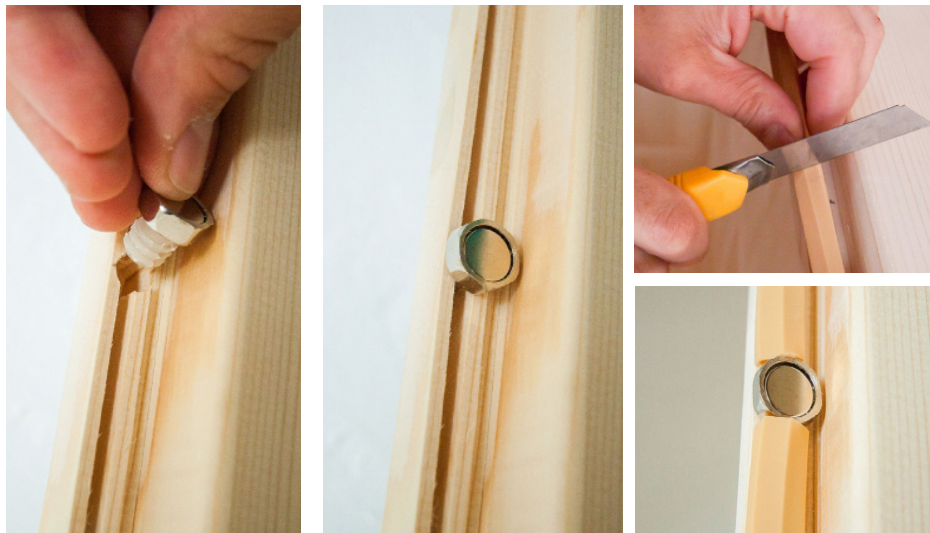

Fig. 35: Montagem da chapa de transferência



5. Limpeza e manutenção

5.1. Limpeza

ATENÇÃO!

Danos na cabina

- Não deite água na cabina e nos componentes eletrónicos.
- A limpeza da cabina e dos componentes eletrónicos não deve ser demasiado húmida.

5.2. Manutenção

A cabina de infravermelhos MiniMy não requer qualquer manutenção.

6. Resolução de problemas

- Para sua própria segurança, em caso de problemas que não sejam abordados de forma suficientemente detalhada nas instruções de montagem, contacte os seus fornecedores.

7. Eliminação

PT



- Elimine os materiais da embalagem de acordo com as diretivas de eliminação em vigor.
- Os aparelhos usados contêm materiais reutilizáveis, mas também substâncias perigosas. Por isso, não deite, sob circunstância alguma, o seu aparelho usado no lixo residual. Elimine-o, sim, de acordo com as disposições válidas localmente.

8. Dados técnicos

Condições ambientais

Temperatura de armazenamento:	- 25 °C até + 70 °C
Temperatura ambiente:	20 °C até + 30 °C
Humidade do ar:	máx. 95%

9. Plano

Uma vez que a madeira é um produto natural, as medidas podem variar ligeiramente.

9.1. Plano “porta à esquerda”

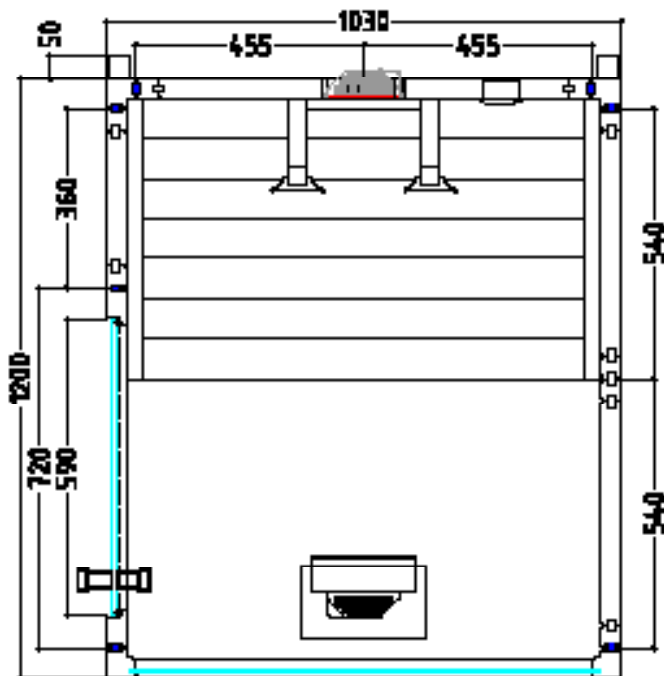

9.2. Plano “porta à direita”

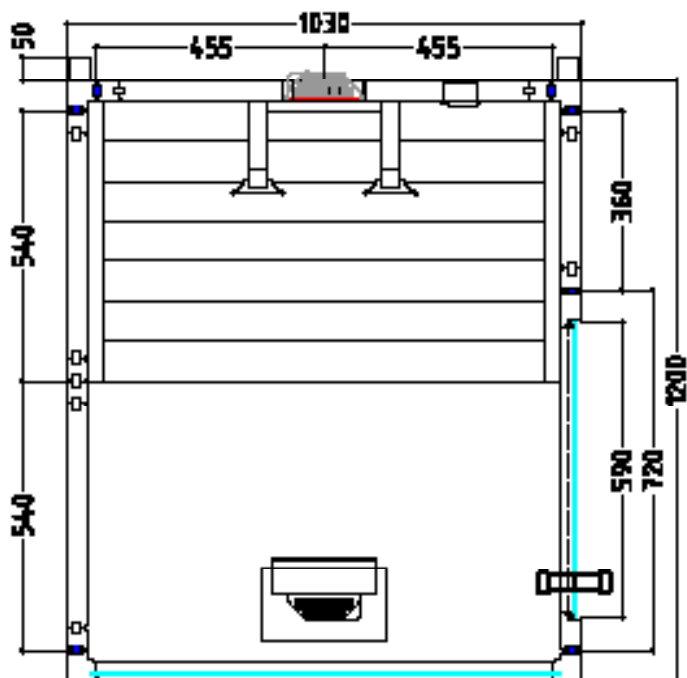

9.3. Alterações na montagem do plano “porta à direita”

Para a montagem do elemento de vidro (Página 16)

Retire os multiclipes do elemento de vidro e monte-os na posição indicada com a ajuda dos moldes fornecidos.

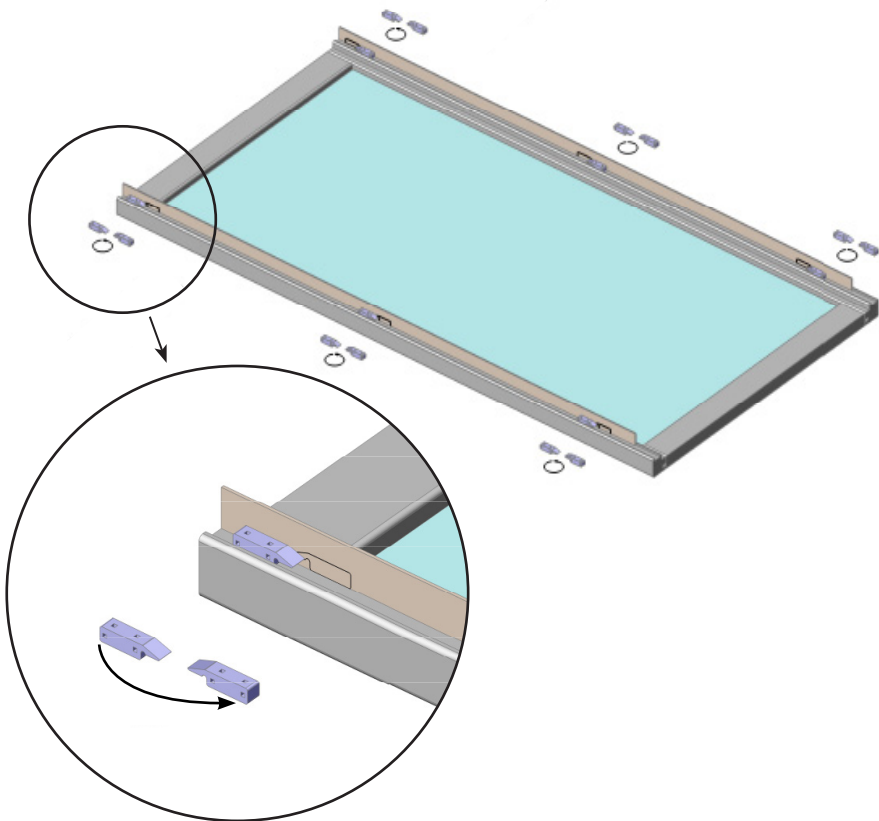

Let's sauna.



@ harviaglobal

GLOBAL

Harvia Finland
Teollisuustie 1-7
40951 Muurame
FINLAND
T +358 207 464 000
harvia@harvia.com

CENTRAL EUROPE

Harvia Austria GmbH
Wartenburger Straße 31
4840 Vöcklabruck
AUSTRIA
T +43 (0) 7672 22 900-50
info@harvia.com